

Do You Really Want to Know About Expansion Chambers?

BY GORDON JENNINGS

$$A_1 = \frac{6-90}{2}$$

Walter Kaaden, who as MZ's chief development engineer had reason to know, said this of expansion chamber exhaust systems: "You'll know when you have the design right, because the chamber will then be impossible to fit on the motorcycle without having it drag the ground, burn the rider's leg, or force the relocation of at least one major component." His remark was made in jest, but contained a lot of unhappy truth. That bulky item of exhaust plumbing we call an "expansion chamber" is for a fact very difficult to mount on a motorcycle. Routed underneath, it devours ground clearance until it is itself devoured by rocks; curled back on the bike's side, it wages a hot battle for space with the rider's entire leg. And always it assaults the eardrums with its fiendish rasp.

Attended as it is by these manifold inconveniences, the expansion chamber exhaust system still has become the ubiquitous help-mate of high-performance, two-stroke engines. Why? Because without it, and a damned nuisance that it is, there is no substitute for the expansion chamber anywhere in the engineer's bag of tricks. Percentage

improvements, between engines fitted with mufflers and otherwise identical engines with expansion chambers, vary according to how good (or bad) the stock muffler is, and are further influenced by carburetor size, port timing, etc. However, the difference will be in the order of 10- to 25-percent and can go as high as 50-percent when used in conjunction with altered carburetion and timing. The degree of difference possible is widely appreciated, and that accounts for the brisk sale of replacement exhaust systems. It also has led many an enthusiast to construct an expansion chamber of his own design.

Sadly, the end result of most people's shade-tree experimental work is simply the discovery that it remains possible to acquire all of the expansion chamber's disadvantages without realizing any of the compensating benefits in performance. Or, as I heard one experimenter (distinguished from the rest only by his honesty) comment, looking bemused at a chamber he had cobbled together for his own bike, "It doesn't make much power . . . but it sure is noisy."

Where did he go wrong? Probably it was

the usual thing: simple, uncomplicated ignorance of how an expansion chamber exhaust system does what it does. What I proposed doing here is to dilute the general ignorance regarding these chambers enough to improve the average man's chances of arriving at more satisfactory results. I must add that I do not regard my own understanding of the expansion chamber's inner workings as being the Almighty's Revealed Truth. My theories are in reasonable coincidence with physical law, and when applied in-formula to specific engines they do seem to shape an expansion chamber that works. Those of you who hold different views on the subject (and experience tells me you cling to your views with a tenacity most people reserve for minor religions) are welcome to them.

Understanding expansion chambers begins with an understanding of the behavior of sonic waves in tubes. These waves, which actually are quanta of energy, zip along through gases at speeds determined by temperature, and have the peculiar property of being reflected back from whence they came by either the closed or open end of the tube in which they are travelling. Even more pe-

CYCLE

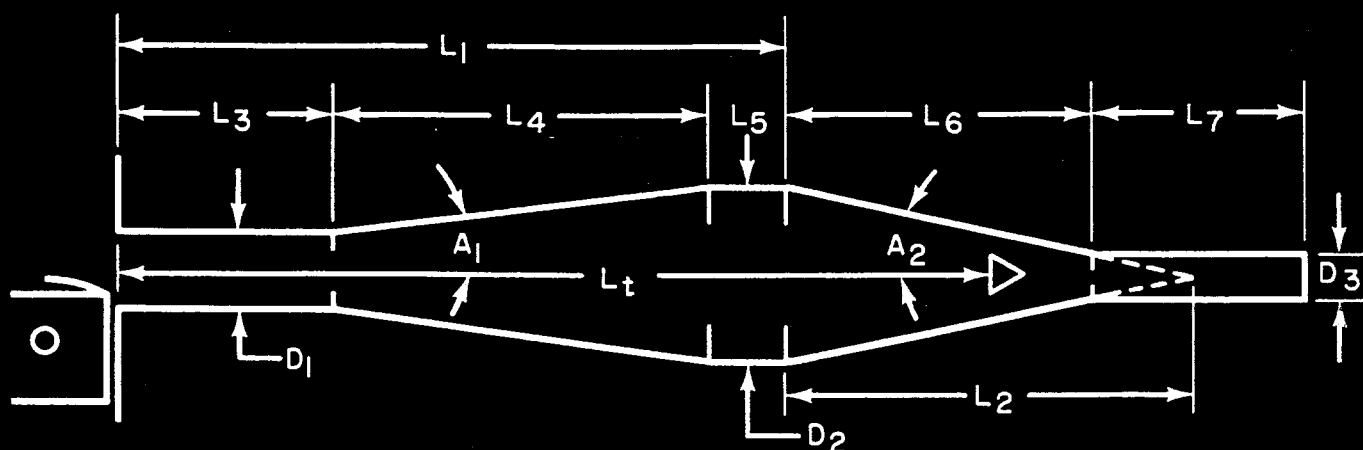

$$L_t = \frac{E_o \times V_s}{N} \quad \text{WHERE, } E_o \text{ IS EX. OPEN PERIOD IN DEGREES}$$

$$V_s \text{ IS SONIC WAVE SPEED: 1700 FT/SEC}$$

$$N \text{ IS ENGINE SPEED IN RPM}$$

$$L_1 = L_t - \left(\frac{L_2}{2}\right)$$

$$L_2 = \left(\frac{D_2}{2}\right) \times \cot A_2$$

$$L_3 = D_1 \times 6 \sim 12 \text{ (SEE TEXT)}$$

$$L_4 = \left(\frac{D_2 - D_1}{2}\right) \times \cot A_1$$

$$L_5 = L_1 - (L_3 + L_4)$$

$$L_6 = \left(\frac{D_2 - D_3}{2}\right) \times \cot A_2$$

$$L_7 = D_3 \times 12$$

$$D_1 = (\text{DIAMETER EQUAL TO EXHAUST WINDOW AREA PLUS } 15 \sim 20\%)$$

$$D_2 = (\text{DIAMETER EQUAL TO } D_1 \times D_1 \times .7854 \times 6.25)$$

$$D_3 = D_1 \times 0.58 \sim 0.62$$

$$A_1 = 1/2 \text{ ANGLE OF DIVERGENCE FOR DIFFUSER: } 6^\circ \sim 9^\circ$$

$$A_2 = A_1 \times 2 \text{ (SEE TEXT Re: } A_1 \text{ AND } A_2)$$

cular is these waves' habit of inverting their sign at the open end of a tube. A positive pressure wave, reflecting at a tube's open end, goes back up the tube as a negative pressure wave; conversely, a negative wave will reflect positively. But reflections from the tube's closed end remain unchanged in sign: positive stays positive; negative does the same.

These aspects of sonic wave behavior are employed in the expansion chamber exhaust system to help scavenge the cylinder—and then to prevent charge loss. To illustrate this, let's watch in slow motion the activity in a typical chamber through a single operating cycle: When the exhaust port opens, exhaust gases still under considerable pressure are spilled out, and a wave-front starts its march down the exhaust system. After moving a short distance in a parallel-wall tube, this wave reaches the megaphone, more properly called a diffuser. Here, the surrounding walls diverge, and the wave reacts almost as though it had reached the end of the pipe—except that the diffuser is a much more efficient converter of wave energy. In the diffuser, a lot of the positive-wave energy is inverted—to a negative wave—and is promptly reflected back up the tube to apply a vacuum at the exhaust port. This vacuum is stronger than one might suppose, having a value of about minus-7.0 psi at its peak. Obviously, it can be of great service in clearing exhaust gases from the cylinder and in hauling the fresh charge up from the crankcase through the transfer ports—which is precisely how it is used in an expansion chamber.

Now if the exhaust system ended there, as was the case back in the days of the supercharged DKWs and "blooey-pipe" Greeves, this vacuuming effect would be a mixed blessing: anything that will pull exhaust products out of a cylinder will pull the fresh charge right after them. Horsepower being very directly related to the weight of the air/fuel charge trapped in the cylinder at exhaust-closing, this side of the megaphone's activity is undesirable.

Right here is where the closed end of the expansion chamber comes into play. While a portion of the original positive wave moving away from the exhaust port has been inverted and sent back to help scavenge the cylinder, the rest has moved onward. Eventually, it reaches the chamber's closed end and this naturally reflects the positive wave back, still positive in sign, toward the exhaust port. Arriving there, it stalls the outflow of the fresh charge and will actually gather up a lot of what already has escaped and stuff it back in the cylinder—holding the charge there until the exhaust port closes.

It must be mentioned here that the expansion chamber is not purely a sonic device:

due to the fact that the chamber bleeds off pressure to the atmosphere through a restricted orifice, and because the pulse of exhaust gases has been expanding to fill the chamber faster than pressure inside can be equalized, there is a general pressure-rise throughout the system. This pressure rise works in concert with the reflected pressure wave to prevent charge loss.

This entire, rather complicated, process works wonderfully well—if all the various waves and pressures surging at the exhaust port are in agreement with what the engine is trying to accomplish at the moment. Unfortunately, the motions of the waves are at a pace stubbornly tied to exhaust gas temperature and supremely indifferent to the engine's requirements. Thus, the primary task in designing an expansion chamber for some particular engine is to establish a length between the engine's exhaust port and the point at which wave reflection occurs in the chamber's baffled end that will return a positive pressure wave to the exhaust port just before the port closes.

To find this tuned length, one must first know the speed at which sonic waves travel in the chamber—and therein lies a great difficulty. As was previously stated, sonic speed varies continuously in the course of a single operating cycle. The diffuser expands the gases and cools them; the baffle causes a degree of recompression and raises gas temperature. And there is an overall cooling of gases within the chamber that also influences wave speed. Fortunately, it is necessary to know only an *average* figure for wave speed. This will, as you might expect, vary somewhat in the specific instance, but my experience indicates that a high average is about 1700 feet per second. At least, that has proven to me to be a good number to use in establishing a length with reference to the anticipated engine speed at maximum horsepower. You can use it with some assurance that it will give you a tuned-length, back to the baffle, that will be close, but slightly longer than what you really want. The system's length can then be trimmed shorter to bring the engine's peaking speed right on target.

Here's a very simple formula for finding that tuned length:

$$L_t = \frac{E_o V_s}{N}$$

Where, L_t is the tuned length in inches
 E_o is exhaust duration in degrees
 V_s is wave speed in ft/sec
 N is engine speed in rpm.

For example: an engine has an exhaust-open duration of 180-degrees, and a power

peak at 7000 rpm. Wave speed we will take, for preliminary design purposes, to be 1700 feet per second.

$$\text{Thus: } L_t = \frac{180 \times 1700}{7000}$$

$$L_t = 43.7\text{-inches}$$

That length, 43.7-inches, is measured from the exhaust port window, at the piston face, back to a point slightly more than half-way down the baffle—which must, in the interest of efficiency, be a cone rather than a flat plate.

The angle given the baffle-cone, and that of the diffuser, are selected with an eye toward engine output characteristics. My own preference in angles of divergence, for diffusers, is a low of 6-degrees and a high of 9-degrees. Diffusers tapered at less than 5-degrees, included angle, are almost impossible to accommodate within the available length; those with angles greater than 10-degrees are inefficient wave inverters and wave energy recovery with them suffers. Researchers have shown that maximum diffuser efficiency occurs with a divergent angle of 8-degrees. However, if you want maximum horsepower and are not concerned about power range, a 9-degree diffuser returns a very strong wave of short duration that will help. Conversely, if you want a broader power range, diffusers having a slower taper will spread the power at some expense to maximum. For any road racing application, I would recommend a diffuser of 8- or 9-degrees. Small-displacement motocross bikes, up to 250cc, are probably best fitted with 7-degree diffusers; big motocross bikes, which usually have more power than their rear tire can apply to the ground, will become more rideable with 6-degree diffusers.

But what about the baffle-cone? As it happens, the strength and duration of the reflected wave, and thus the engine's power characteristics, are influenced by taper here as well. Within limits, the correct taper will be twice that of the diffuser. Thus, an 8-degree diffuser is matched with a 16-degree baffle cone. However, you may vary this a couple of degrees—sometimes more—in the interest of obtaining precisely the power characteristics you need. For example, a 6-degree diffuser capped with a 20-degree baffle-cone would produce a good spread of power right up to the power peak—and then cut the engine dead just beyond. The rule here is that the diffuser influences the power curve below the peak most strongly, while the baffle-cone's taper has its effect on the curve after its peak. Again, as in the diffuser, a long, shallow-taper baffle-cone gives a good spread of power at some cost to maxi-

(Continued on page 86)

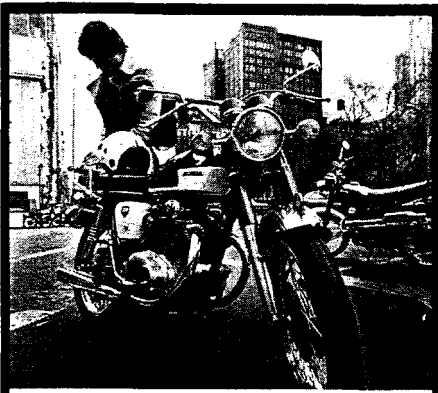

PIRELLI A TIRE FOR EVERY BIKE

UNIVERSAL

350-15	275-17	325-18	325-19
275-16	300-17	350-18	350-19
325-16	350-17	400-18	400-19
350-16	250-18	SUPERSPORT	
500-16	275-18	250-19	
225-17	300-18	275-19	
250-17	325-18	300-19	

LIGHT MOTORCYCLE (Rib)

2 3/4 x 16	2 x 18	2 3/4 x 18
2 1/2 x 17	2 1/4 x 18	1 3/4 x 20

LIGHT MOTORCYCLE (Universal)

2 1/4 x 16	2 3/4 x 18	2 x 22 1/2 WW
2 1/2 x 16	2 x 19 WW	2 1/2 x 22 1/2
2 1/4 x 17	2 1/4 x 19	2 x 13 WW
2 x 18	1 3/4 x 20	2 1/4 x 23
2 1/4 x 18	2 1/4 x 20	

SCOOTER & MINIBIKE (Universal)

300-5 Rib 376	400-8	350-10 WW
350-5 Uni 433	275-9	300-12
350-7SC 80 Stud.	300-10	350-12
350-8	300-10 MC	250-13
350-8 WW	350-10	2 1/4-16

RIB

250-17	275-18	250-19	325-19
275-17	300-18	275-19	350-19
250-18	350-18	300-19	

Trials & Motorcross Spanish Tread

400-18 MC	350-19 T	300-21 MC
400-18 T		

MOTORCROSS

250-17	350-18	250-19	350-19
300-17	400-18	275-19	400-19
300-18		300-19	

SEMI-KNOBBY

325-16	250-17	350-18	250-19
--------	--------	--------	--------

TUBES

350 x 8	300/325 x 16	350 x 18
400 x 8	350 x 16	400 x 18
275 x 9	500 x 16	250 x 19
300 x 10	225 x 17	275 x 19
350 x 10	250/275 x 17	300/325 x 19
300 x 12	300 x 17	350 x 19
350 x 12	350 x 17	400 x 19
250 x 13	200 x 18	175 x 20
350 x 15	225 x 18	225 x 20
275 x 16	250/275 x 18	225 x 23
	300/325 x 18	

GET IT AT YOUR
PIRELLI DEALER OR WRITE:
COSMOPOLITAN MOTORS
HATBORO, PA. 19040 • (215) OS 2-9100

CIRCLE NO. 65 ON READER SERVICE PAGE

CHAMBERS *Continued from page 46*

mum output, and *vice versa*.

While the baffle-cone must be placed very precisely with regard to distance from the exhaust port window (this distance measured along the exhaust system's centerline), there is no single point within the cone where reflection occurs. In fact, a wave entering the cone begins to reflect back right from the moment of entry, and reflection continues over the cone's entire length. There is, however, a midway point in terms of the reflection—which is not, as you might suppose and as I once thought, halfway down the baffle cone. To find this mean point of reflection, imagine that the baffle cone is complete, rather than truncated at its small end to make a hole for the outlet pipe. If you use half the distance between the cone's big end out to its imaginary tip, that will give you your mean reflective point. For example, a cone having a 3-inch diameter and converging on a 16-degree included angle would have a length of about 7.1-inches if cut short to join with a 1-inch outlet pipe—but its complete length is 10.7-inches. Thus, you would use a point 5.35-inches back from the cone's open end in establishing the expansion chamber's tuned length.

Anyone who has watched the development of expansion chambers over the years may have noted that the biggest change in their appearance has been in girth. The early examples were fairly slender—but that was before researchers established that diffusers, within the divergencies and pressures applicable here, offer maximum efficiency when their cross-sectional areas for inlet and outlet are proportioned as 1:6.25. That is to say, when the sectional area at the diffuser's big end is 6.25-times that of the inlet end. So, if the inlet diameter is 1.5-inches (to match a lead-in pipe of the same diameter) then its area there will be $(1.5 \times 1.5 \times .7854) = 1.767$ square inches, and to find outlet area multiply 1.767 by 6.25, which equals 11.05-in². Knowing that, you then must find a diameter that will provide 11.05-in² of area, and working back from the formula for finding area, $D^2 \times .7854$, you arrive at diameter—which in this instance is 3.75-inches.

Determining the length of a diffuser, or a baffle-cone, after the major and minor diameters and taper have been established, is a simple exercise in trigonometry. I use the following formula:

$$L = \frac{D_2 - D_1}{2} \times \text{Cot } A$$

Where L is length:

D₁ is the minor diameter

D₂ is the major diameter

Cot A is the cotangent of half the diffuser's, or baffle cone's, angle of divergence (or convergence).

For example, for a diffuser having a 1.5-inch minor diameter, a 3.75-inch major diameter, and a divergent angle of 8-degrees,

$$L = \frac{3.75 - 1.5}{2} \times 14.3007$$

$$L = 16.1\text{-inches}$$

Having covered diffusers and baffles and tuned lengths, we can now grapple with lead-in and outlet pipes. The former's diameter is established primarily by the size of the engine's exhaust port. If the engine has an exhaust port window with an area of, say, 1.7-in², the lead-in pipe connecting this port with the diffuser should have a cross-sectional area 15-20 percent larger, or an inside diameter (in this example) of 1.58- to 1.61-inches. *But* (and here's where choice becomes difficult) increases in lead-in pipe area up to 50-percent greater than port area may be indicated if for reasons of convenience in installation it becomes necessary to use an unusually long lead-in pipe. Also, a long, large diameter lead-in pipe may be helpful in broadening the engine's power range downward—but then the same effect may be obtained with a shorter, smaller-diameter pipe joined to a shallow-taper diffuser. The pattern is that large diameter pipes behave as though they were shorter than their actual length, and small-diameter pipes *vice-versa*.

In actual application, the matter of lead-in pipe diameter will have been settled for you by those who designed your engine—and who gave the exhaust port its diameter. There isn't much you can do to alter that. So I offer only a rule-of-thumb for length: For a power curve biased toward maximum output, the lead-in pipe's length should be equal to between 6 and 8 diameters. Thus, a pipe having a diameter of 1.5-inches would be between 9- and 12-inches in length—and this figure includes the length of the exhaust port from its window in the cylinder to the connecting flange. A broader power range will be obtained with lead-in pipe lengths of between 9- and 11-diameters. Should you not be able to make the connection between port and diffuser with lengths in these ranges, then alter the diameter in the appropriate direction. Similarly, if you want to broaden or narrow the power range, to improve low speed torque or raise the power peak, and there isn't room to play with lead-in lengths, you can make the adjustment with diameter.

The outlet pipe is a less complicated matter. It functions as a pressure-bleed resistor, which means that there is more than one "right" combination of diameter and length. Nonetheless, I have found that something very near the optimum is obtained with an outlet pipe diameter between .58- and .62-times lead-in size. Thus, if lead-in pipe diameter is 1.5-inches, then outlet diameter should be between .87- and .93-inches. Chambers having larger or smaller volumes than those developed as outlined here may require correspondingly smaller and larger outlet pipe diameters—

CYCLE

BEST LOW COST HEAVY DUTY WELDER
MONEY CAN BUY \$18.95 POSTPAID

10 DAY MONEY BACK TRIAL—
LIFETIME GUARANTEE

READY TO USE
NO MORE TO BUY

GET: Welder in rugged metal cabinet, heavy duty cables and ground clamp, full face helmet, adjustable torch and rod holder, simplified welding manual and

FREE TWO BIG PACKS
 Instant arc-welding rods, brazing rods, 1/4 carbons, solder & flux.



Weld, braze, solder, cut almost any thing of metal including aluminum. Use regular 1/8" rods, 1/4" carbons. Operates on ordinary home 110V outlet, 30A fuse. Make or repair cars, boats, toys furniture, bicycles, farm and garden equipment. Adjustable carbon-arc torch to easily regulate heat up to 11,000° for light or heavier welding without changing heats or cables. HUNDREDS OF THOUSANDS SOLD IN 30 YEARS. PROOF YOU CAN'T BUY A BETTER WELDER FOR LESS. LIFETIME GUARANTEE. If ever inoperative, return prepaid, we will repair and reship without charge. FREE TRIAL. If not completely satisfied, return in 10 days and we will refund purchase price. SEND ONLY \$2.00, pay \$16.95 plus C.O.D. and delivery charges or send \$18.95 for prepaid shipment in Continental U.S.A. Ill. res. add 5% sales tax. **FOUR WAY WELDER CO.**, 1810 S. Federal St., Dept. C32 Chicago, Ill. 60616

Boston Cycles!

BSA • BMW • YAMAHA • NORTON • DUNSTALL
 PARTS/CYCLES SHIPPED ANYWHERE!

124 Brighton Ave., Boston, Mass. 02134 617-254-1175

EURO-BIKE



DISCOVER EUROPE ON A BIKE!

- INDIVIDUAL ECONOMY JET FARES OR GROUP INCLUSIVE TOUR PACKAGES
- OVER 15 MAKES OF TAX FREE MOTORCYCLES FROM 50CC - 750CC
- LICENSE, REGISTRATION & INSURANCE INCLUDED
- RETURN SHIPMENT FROM ANYWHERE IN EUROPE TO THE U.S. OR CANADA

.....

• Euro-Bike Inc. Dept. 4
 • 810 18th Street, N.W.
 • Washington, D.C. 20006

• Name _____ Age _____
 please print or write plainly

• Address _____

• City & State _____ Zip _____

the inverse rules applies. And the outlet pipe length? Make it 12-diameters and forget about all the trimming others (and I) have suggested in the past. You won't get any closer without a dynamometer to guide your efforts.

A word of caution: don't make the outlet pipe too small in diameter; always select the next larger size, as compared to what my "rule" says is correct, from the available stock of tubing. My dynamometer testing has shown that the engine temperature, particularly that of the piston, rises very sharply when outlet diameter is restricted even slightly more than the optimum for power. Conversely, an outlet pipe slightly too large has an equally slight depressing effect on power, but allows the engine to run at much more comfortable temperatures. Incidentally, a too-steep taper in the baffle-cone will have much the same effect. I do not recommend convergent angles exceeding 30-degrees (included) for these cones.

Neither can I recommend the very common practice of flattening, notching and denting expansion chambers to make them fit more tidily on the motorcycle. Diffuser efficiency is compromised by any departure from a round cross-section. Overall efficiency suffers from notching, anywhere, as sonic waves feel every change in section. On the other hand, the exhaust system can be looped and jogged all over the place without any bad effect. You must be careful about providing a smooth passage in the lead-in pipe and at the diffuser entry: gas velocity in this part of the system is very high, and although sonic waves are indifferent to abrupt turns, gas flow is not.

Expansion chambers constructed to the design principles provided here will not represent the optimum. Following the formulae will bring you close, but there will always be room for improvement in light of what the dynamometer reveals. Still, my experience is that chambers built to these formulae are quite good, lifted right off the paper. They are better, in fact, than most of those being sold as replacements for stock mufflers.

Obviously, I do not expect you to take my unsubstantiated word as proof of all I have said. To prove the point, I am constructing an expansion chamber, to formula, for trial on a standard Yamaha DT-1E. The people at Webco permit me use of their excellent dynamometer facility, which will allow taking power curves for the Yamaha engine with its stock muffler, and then with my expansion chamber. You will be advised of the results of that testing, and also what sort of power the Yamaha develops with a sampling of chambers made for it by others. Finally, we'll investigate the effects of changes in port timing, compression ratio and carburetion—and cap it all with some information about mufflers to quiet the expansion chambers. We can live with the chambers' bulk; unless we quiet the things, all the rest will not matter.

Norton - SALES PARTS

Western Canada's Largest stocking dealer for all 750cc models!

MAIL ORDER SERVICE ANYWHERE!

Chopper Goodies for:

NORTON	HONDA
TRIUMPH	YAMAHA
BSA	KAWASAKI
H-D	SUZUKI, etc.

FREE CATALOGUE

CHARIOT CYCLE LTD.
 Box 3534, Station "B," 303 Selkirk Ave.
 Winnipeg, Manitoba, Canada

LOWEST PRICES ON CYCLE TROPHIES

WHOLESALE FACTORY-DIRECT
FREE, FAST DELIVERY

Send for your FREE CATALOG

OVER 300 TROPHIES TO CHOOSE FROM

Eddie Retchins TROPHY WORLD, INC.
 A Subsidiary of TROPHY ENTERPRISES, INC.
 Dept. FC
 6400 N.W. 77th COURT
 MIAMI, FLORIDA 33166

GUIDE TO EARNING EXTRA INCOME
A Ziff-Davis Publication



All new—first time ever published! Everything you need to know about full and part time money-making. How to start your own mail order business • 22 proven and profitable home business ideas • How to earn extra \$'s • Franchising • Vending machines • Advice on cutting living costs. Only 75¢.

Order from Ziff-Davis Service Division,
 595 Broadway, New York, New York 10012.
 Enclose an additional 25c for postage and handling.

kosman specialties

MANUFACTURERS OF:

- ALLOY RACING WHEELS
- QUICK CHANGE SPROCKETS
- DISC BRAKES
- OIL TANKS
- OIL FILTERS

DISTRIBUTORS OF:

- TITAN HY-VO PRIMARY DRIVES
- REDLINE RACING FRAMES
- ROUTT BIG BORE CYLINDERS
- ARD MAGNETOS

SEND \$1.00 FOR CATALOG

KOSMAN M-C SPECIALTIES
 340 FELL STREET
 SAN FRANCISCO, CA. 94102

Do You Really Want to Know About Expansion Chambers?

BY GORDON JENNINGS

Part 2

More than a dozen exhaust systems, two each of carburetors, pistons, cylinders and heads, two months of grinding, sawing, snipping and welding, and fifty hours of peering at a dynamometer scale went into the making of this report. We promised you an investigation into the effects of sundry expansion chambers, carburetors, compression ratio and porting on a two-stroke engine, and by Gadfry we have *investigated!* Some of the results of that investigation are, fairly startling.

Central to all the above-described activity was a Yamaha DT-1E, of which there are about umpteen jillion in off-road service. This sheer ubiquity was half our reason for choosing the Yamaha: whatever we learned in the course of our investigation would have direct application for a large portion of *Cycle's* readers. The other half was the Yamaha's proven reliability. We anticipated many, many hours of full-throttle, full-load running, and a halt in mid-experiment to rebuild an engine would have stalled progress—as well as casting doubt's shadow over the validity of results obtained.

A final and essential ingredient in our plans was the dynamometer facility at Webco. This motorcycle accessory firm's owners, Tom Heininger and Bob Hughes, decided a couple of years ago that rule-of-thumb designing and seat-of-pants testing was no longer appropriate in what had become a major industry. So they spent many months and many, many thousands of dollars in the creation of a first-rate research and development shop. This shop contains all the machine tools, etc., for experimental fabrication—and the best dynamometer we've seen for testing same. Webco's dynamometer is built around a Schenke eddy-current brake, with automatic controls and a digital tachometer, and has been certified by the Los Angeles County's Department of Weights and Measures for accuracy. You can believe the numbers you get with this kind of precision instrument, and we are extremely fortunate to have had access to Webco's dynamometer facility—and shop—for this expansion chamber project.

Before any modifications to the Yamaha DT-1 were performed, its engine (nicely broken in, after 800 miles of running) was disas-

sembled, checked, reassembled and carefully tuned to factory-recommended specifications. We had a hunch that the engine would not deliver the advertised 21 bhp, and we wanted to avoid being accused of having done our work with a "bad" engine. Why the hunch? Because past experience with other motorcycles has shown us that rarely, if ever, does advertising mesh with reality in matters concerning horsepower. We are prepared to accept discrepancies in the order of 8-10 percent, because Webco's dynamometer is chain-driven, off the motorcycle transmission's output sprocket. Motorcycle factories may very well take their power readings right from the end of the crankshaft. But we are not going to believe that power losses can ever be much more than 10-percent: there is a loss of about 3-percent where power is transferred across gears, and perhaps there is a 2-percent loss in the drive chain and sprockets; that adds up to 8-percent for most motorcycles. The actual difference between what we usually find being delivered to the rear wheel, and what advertising claims, is much greater. But ad copywriters aren't engineers either.

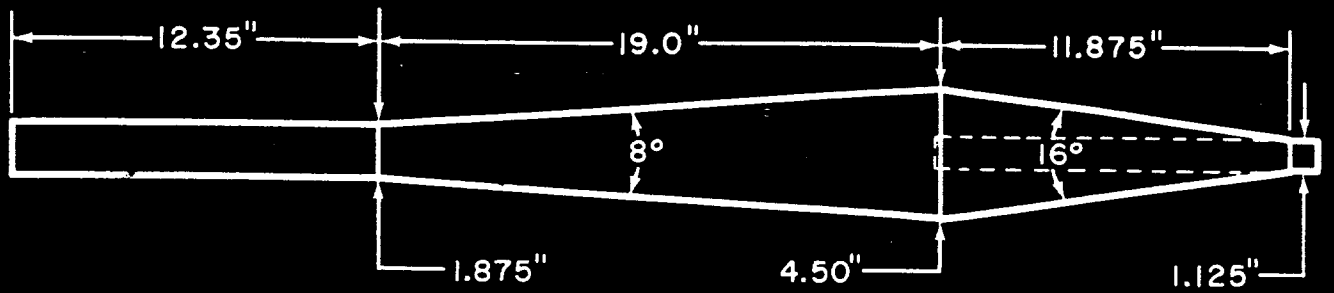

CHAMBER A

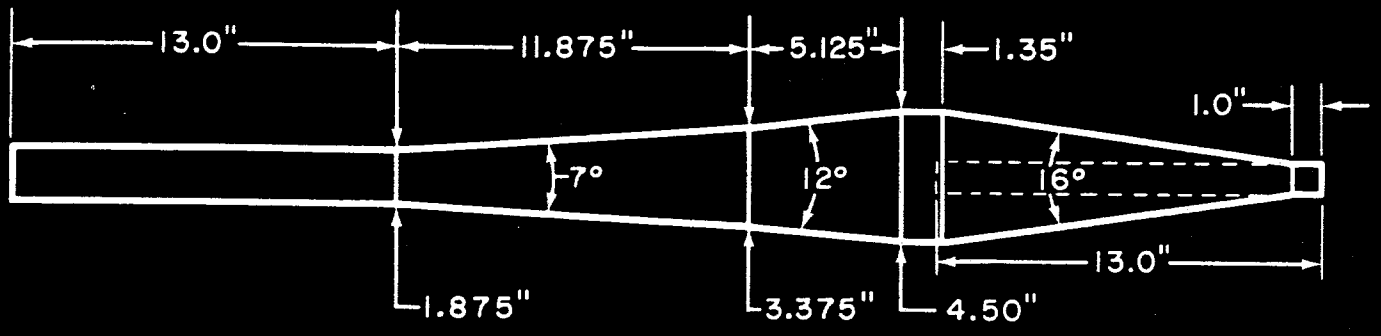

CHAMBER B

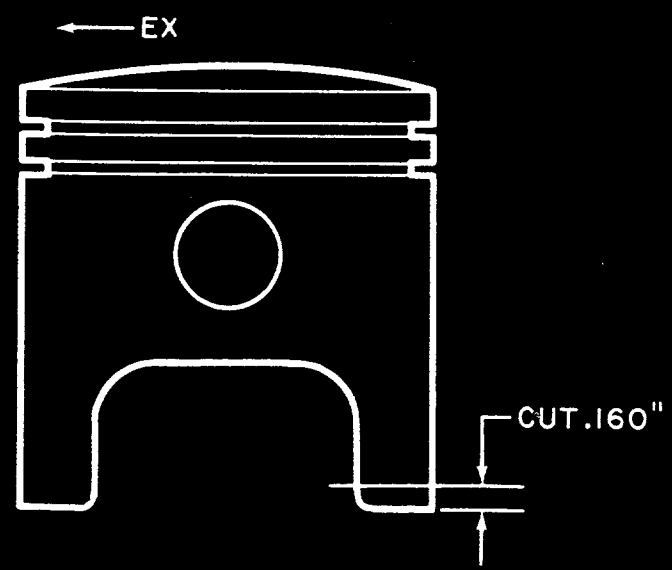

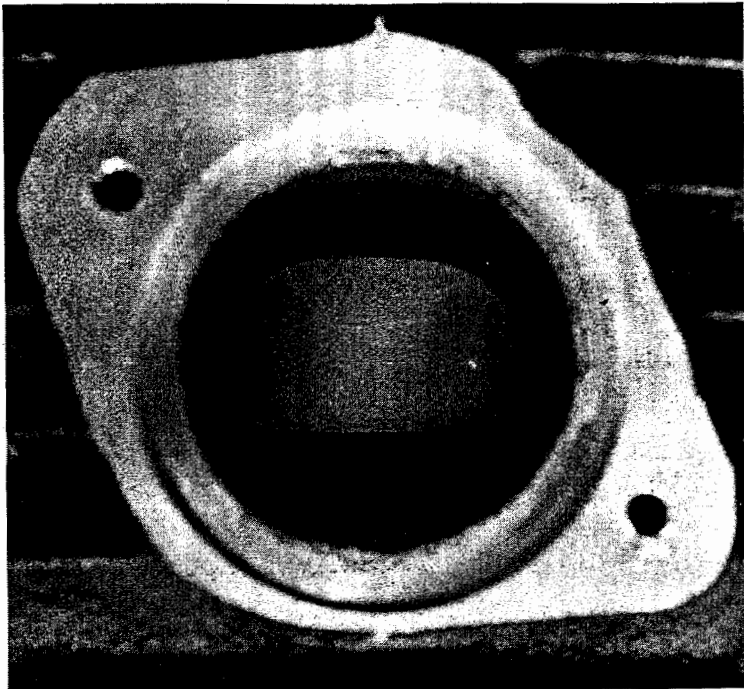

The exhaust port width was increased to 1.71-inches; keep port shape standard.

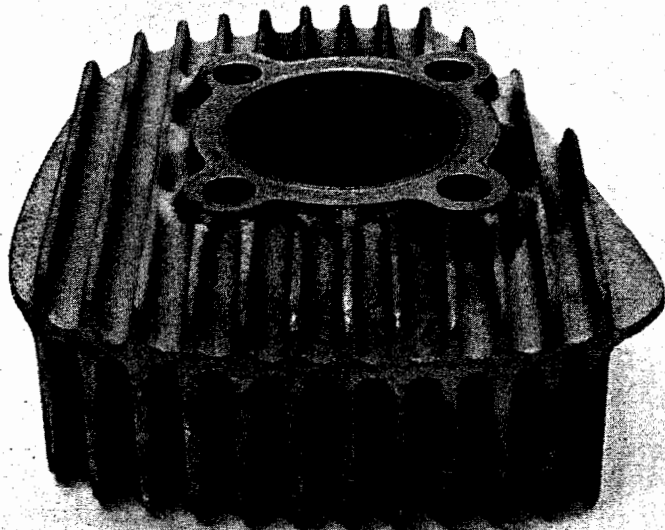

The Webco cylinder head is thicker, has more cooling-fin area than stock item.



A dynamometer can compress a year of field experimentation into one week.

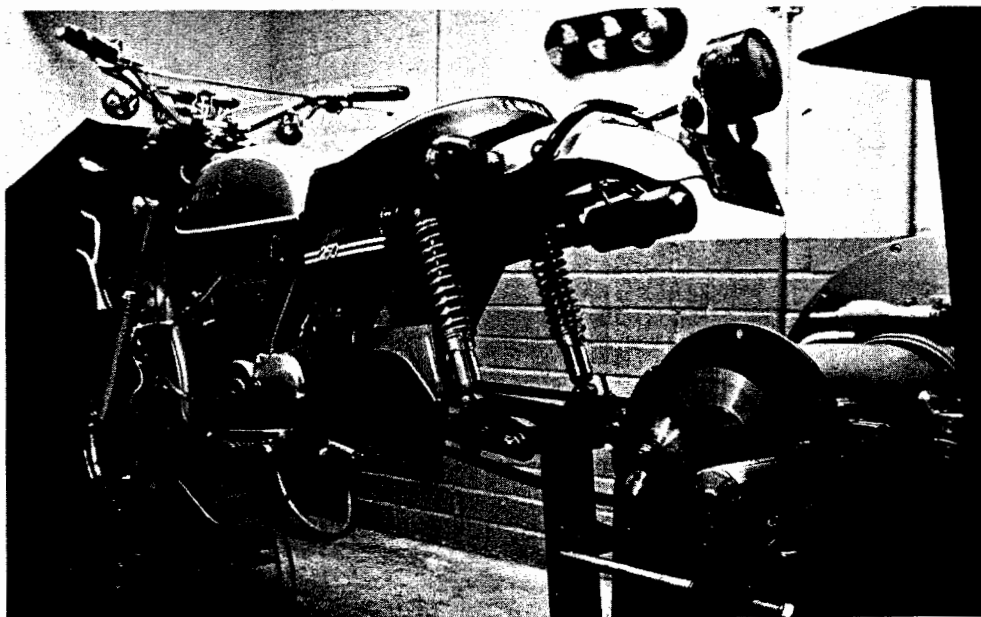

DT-1 on the dyno: Jennings' pipe, ported cylinder, shortened piston and Webco head returned 22.9 bhp.

Perhaps these engines will flash something near claimed output; they will not sustain it. We have found that power output falls very rapidly as a two-stroke engine comes up to operating temperature, with a drop of 20 percent between cold readings and those taken after running temperatures have stabilized. This could, added to transmission losses, account for the difference between claimed power output and our figures. Even so, we consider our method—which reflects the power actually being delivered to the motorcycle's rear wheel under "normal" operating conditions—to be more accurate. The power an engine might develop at its crankshaft, cold, is of little interest to the rider charging up a sand-wash on a warm summer day.

In any case, we bolted the Yamaha DT-1 in place beside the dynamometer, hooked up the chain, and after bringing it up to operating temperatures, made a complete run—taking readings at 500 rpm intervals from 3500 rpm

CYCLE

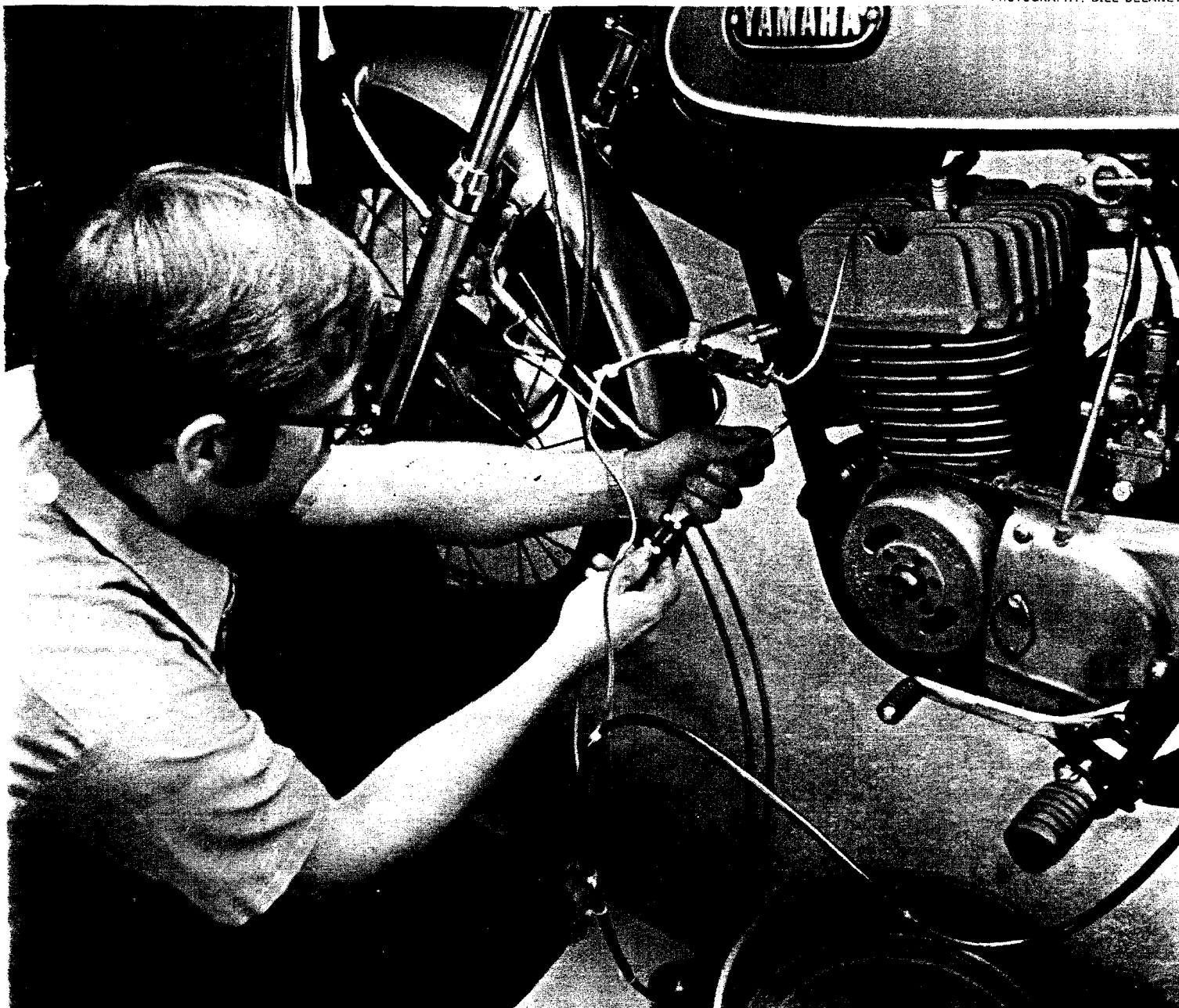

The Webco dyno facility has a temperature metering system which proved its worth during tests. Webco head (pictured above) replaces standard one.

up to the engine's 7500 rpm redline. We had determined, in advance, that not even a duffer rider used anything below 3500 rpm—and we had decided to accept Yamaha's judgement of what constituted a safe upper limit for the DT-1 engine. And how much horsepower did the Yamaha actually deliver to its rear wheel? The difference between the claimed 21 bhp at 7000 rpm and what we observed was considerable: 5.14 bhp, to be exact. Our stock, freshly-tuned DT-1E showed a maximum of 15.86 bhp, at 6000 rpm.

Our primary purpose in this project was to demonstrate that an expansion chamber exhaust system built to the formulae I presented in the March, 1972 issue of *Cycle* would perform as claimed. So I set to work with slide-rule and pencil, designing an expansion chamber for the Yamaha DT-1. Using the exhaust-open period of 172-degrees and anticipating a power peak at 7000 rpm, the chamber's tuned length was to be 41.75-inches (measured from

the exhaust port window to the point of mean reflection inside the chamber's baffle cone). All the other dimensions would depend, more or less directly, on the lead-in pipe diameter, and that's where a lot of trouble fell upon my head before I could get any further.

As it happens, the Yamaha's lead-in pipe, the tube that connects the exhaust port and the muffler, had a diameter just over $2\frac{1}{8}$ -inches—which may be right for Yamaha's muffler; it would be all wrong for my expansion chamber. On the other hand, my usual system of making lead-in pipe diameter to exhaust port area plus 15-20 percent didn't seem like the best possible approach either, as the exhaust port's outlet diameter in the DT-1 engine is larger than that, and engines do not like sudden constrictions in their exhaust outlets. Then it was discovered that $1\frac{7}{8}$ -inch exhaust pipe tubing would plug right into the Yamaha engine's exhaust spigot, so for lack of any better answers, I decided to use that di-

ameter for a starting point in all the rest of my calculations.

Which instantly brought me up against yet another problem. The inside diameter of $1\frac{7}{8}$ -inch O.D. tubing (with a wall-thickness of .049-inch) is 1.777-inches, and when you apply the 1:6.25 area rule, the diffuser outlet diameter becomes 4.44-inches, and even using a divergent angle of 8-degrees, the diffuser will have a length of 19.0-inches. Add another 7.9-inches for the distance to mean reflection back inside the baffle cone, plus 2.5-inches for exhaust port length, and you have already used 29.4-inches of the 41.75-inches of tuned length—which leaves only 12.35-inches for the lead-in pipe's length. That is getting pretty short, when used in combination with an 8-degree diffuser, for any kind of power spread, but I had promised you a test of a purely by-formula expansion chamber, so I went ahead and constructed a chamber to the dimensions just mentioned.

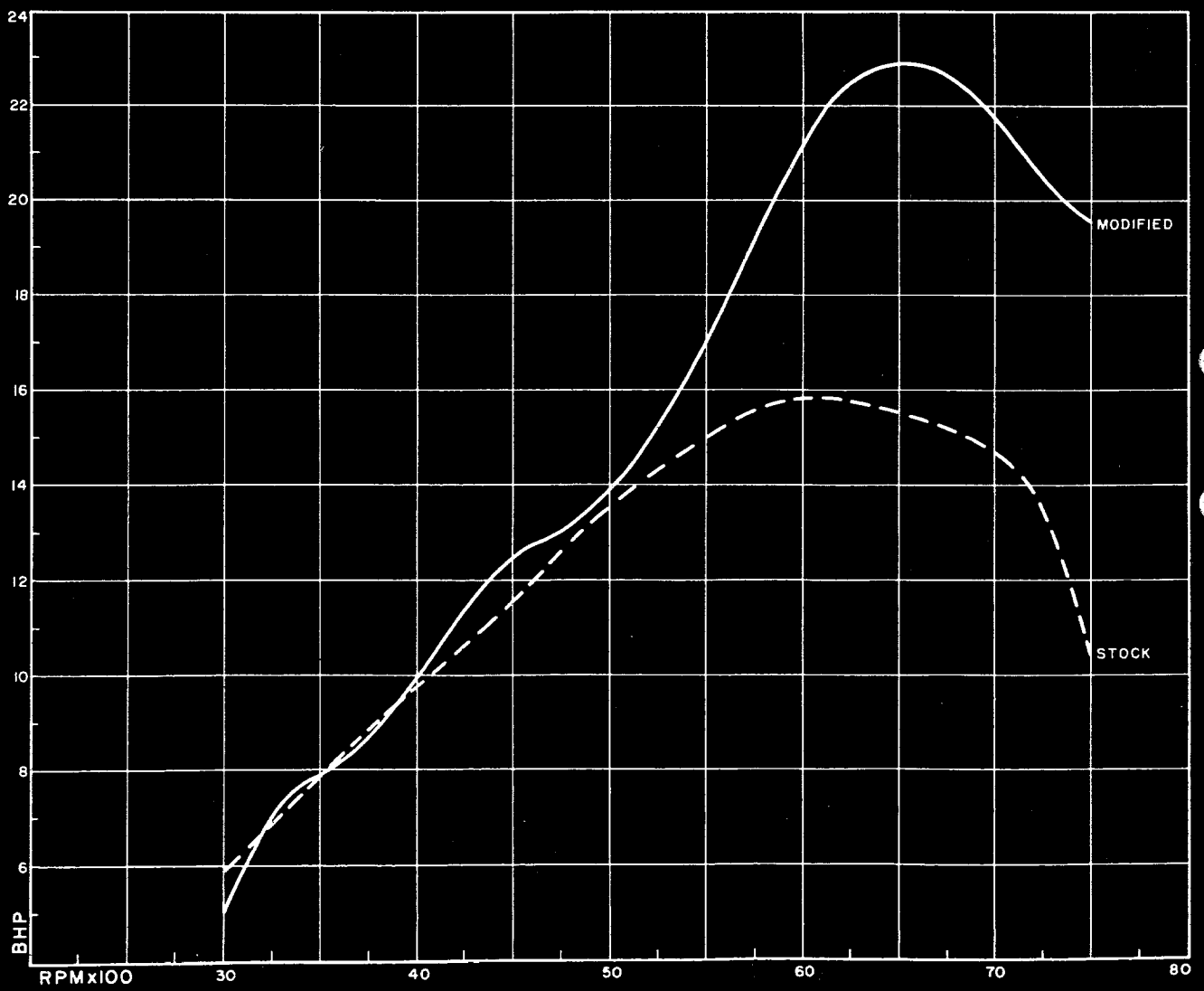
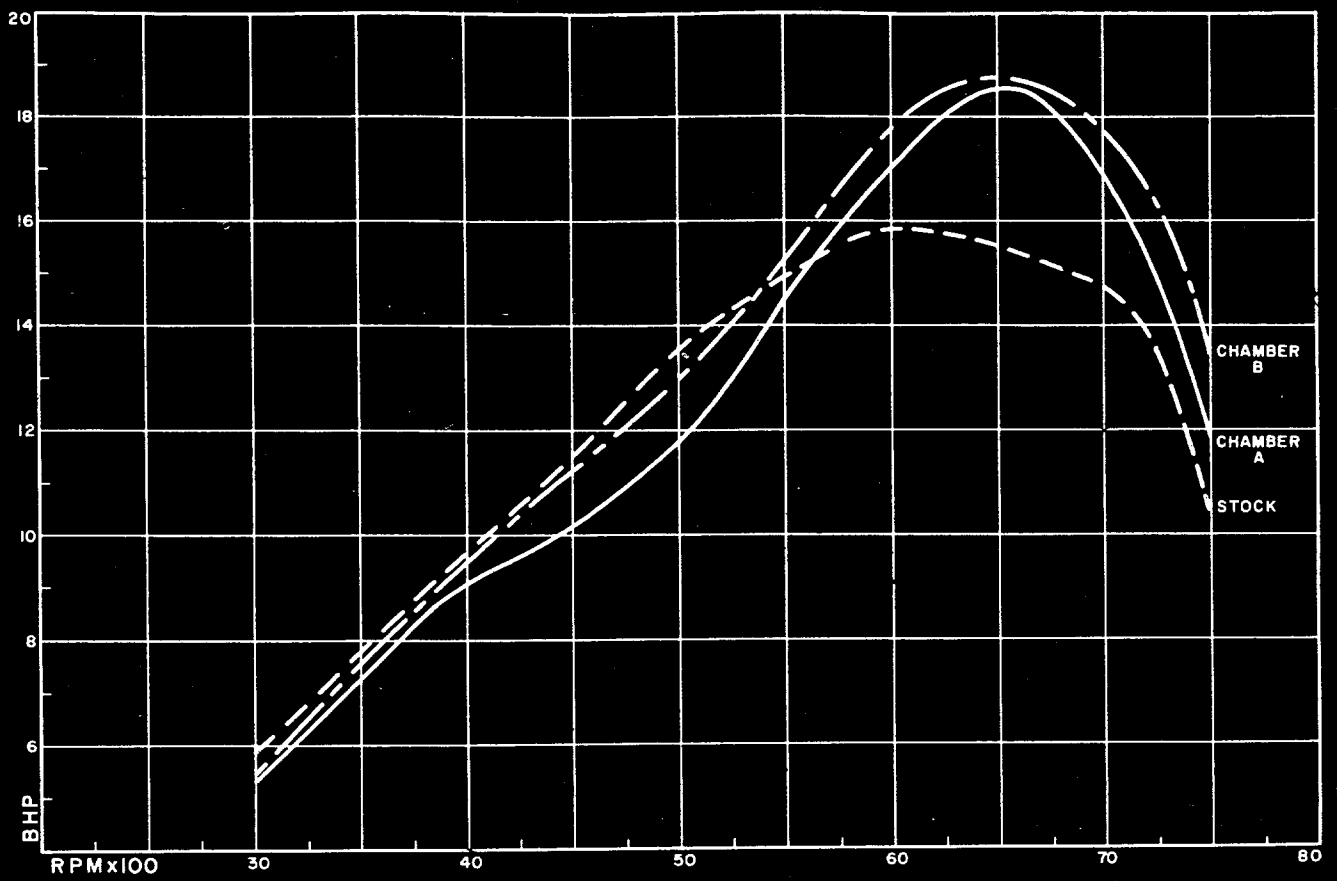

Did it work? You could say so, because just switching from the stock muffler to my expansion chamber bumped maximum engine output from 15.86 bhp @ 6000 rpm to 18.52 @ 6500. That's an increase of 16.7-percent, and it isn't bad at all, if you're just considering maximum power. Unfortunately, there's more to performance than that: what really counts is power range—which in this instance had to be, at minimum, from 5000 rpm to 7500 rpm. The DT-1's transmission and normal riding conditions will not permit staying right on top of the power peak. My first "formula" pipe was, in those terms, less than a resounding success: at 5000 rpm, it dropped the engine from 13.54 bhp (with the stock pipe) to 11.77 bhp; at 5500 rpm, the figures were 14.92 bhp for the stock pipe and 14.49 for my expansion chamber; and at 6000 rpm it was 15.86 bhp compared with 16.97.

So, my expansion chamber was an improvement over the stock muffler, but the improvement was a little too high on the engine speed scale to be satisfactory. An expert rider would think it marvelous, because such riders run flat-out most of the time anyway; lesser lights would have found it somewhat peaky. And most of us definitely are "lesser lights" and need a better spread of power.

While performing the tests that gave us these power figures, we noted an ominous warning from the temperature gauges. Particularly, spark plug temperature. The fact is that with this expansion chamber, cylinder charging at the torque peak (also at 6500 rpm) had been improved to the point where we were getting serious overheating. Something of the same effect was noted with the stock muffler, and in both cases had we not had temperature metering equipment to warn us of impending disaster, an engine failure would have resulted before power readings completely stabilized. The overheating was there even with the stock muffler; it became an overwhelming problem with the expansion chamber.

There was a question implicit in these findings: would the engine overheat with any expansion chamber? We were prepared to find out, for we had at hand a representative sampling of chambers manufactured as accessories for the DT-1, including chambers from Hooker, Torque Engineering, MCM, and one from Strader Engineering—in addition to Yamaha's GYT-kit and MX chambers for the DT-1. We tried them all . . . or, to be more accurate, we *tried* to try them all, for all produced such serious overheating that it was too dangerous to try for a stabilized power reading at the torque and horsepower peak. Pressing the issue would have resulted in a piston failure (as had happened in the past with several engines). When cylinder-head temperatures get beyond a cer-

tain point (which we have found to be about 450° F., measured at the spark plug washer) preignition follows and there is an abrupt sag in power, after which the piston crown caves in.

It may be of interest that my expansion chamber, bolted on a stock DT-1 engine, did edge all the others for power. But that is of little value in real terms, because all of the chambers we tried would urge the engine to fatal exertions. There was a cure, of sorts, in switching to a larger mainjet in the carburetor, as the cooling effects of a lot of raw gasoline whooshing around inside the engine were sufficient to bring spark plug temperature down below the disaster level. The problem was that while this kept the piston from melting, and even provided a slight boost in peak horsepower, the over-rich mixture was simply too rich for clean running at anything other than peak revs. In short, the engine became even more peaky—and developed a marked tendency to foul its plug at low revs.

Webco came to the rescue at this point, with a replacement cylinder head Bob Hughes has developed for the DT-1. There's nothing really tricky about the Webco cylinder head: it has a part-spherical combustion chamber centered over the bore and surrounded by a small squish band, and is cast of a very common aluminum alloy. It works better than the stock cylinder head however, probably just because it is a lot thicker and has more cooling-fin area. Cranking pressure with the stock head was 120 psi, and that was all the compression the engine would tolerate at sea level even with the stock exhaust system. Spark plug temperatures with the Webco head were about 30° lower, consistently, with cranking pressure at 155 psi. The increased compression ratio was good for a 2.5-percent boost in power (as compared to the stock head) over the entire power range, but we do not consider that to be as important as the improved cooling. It could make the difference between clearing or not clearing a sandwash to you—and the Webco cylinder-head made the big difference in our experiments with expansion chambers: without it, we could not have gone anywhere.

Having overcome the heating problem, we proceeded with our testing of expansion chambers. My own formula chamber, in conjunction with the Webco cylinderhead, pushed engine output up to 19.93 bhp @ 6500 rpm. The Hooker expansion chamber delivered 19.36 bhp, at 7000 rpm. Torque Engineering's chamber came in with 19.49 bhp, also at 7000 rpm; the MCM chamber gave us 18.10 bhp @ 6500 rpm; and the Strader Engineering chamber, 18.93 bhp @ 7000 rpm. We also tried the Yamaha GYT-kit and MX expansion chambers, which

gave 19.79 and 19.36 bhp, respectively—both at 6500 rpm.

In terms of peak power, my first formula pipe won this contest—but I would be less than honest if I failed to tell you that the real winner was the chamber from Strader Engineering. This chamber of Strader's was about an even horsepower short at the power peak, but it was very strong from about 4000 rpm right out to the 7500 rpm redline. My formula pipe, in contrast, didn't begin to work well until the engine was brought past 5500 rpm, and wasn't as strong after passing its peak. The MCM chamber, incidentally, showed much the same characteristics as the Strader—but was somewhat stronger mid-range, and dropped quite sharply past the power peak. All the rest of these chambers showed the same general characteristics as the formula expansion chamber: their effectiveness was limited to a narrow range between 5000 and 7000 rpm, which makes them acceptable to the expert rider, in racing applications, but otherwise tends to limit their usefulness. A regrettable state of affairs, in a world where most riders do most of their riding away from the track. Clearly, what was needed here was an expansion chamber that combined my formula chamber's peak output characteristics with the broad range capability of the Strader and MCM chambers.

Now the combination just mentioned is easier to want than to get, and I have not had much luck in that direction in the past. Still, it was worth a try, so I thought and calculated a great deal (I won't bore you with a complete accounting of all the mental machinations) and eventually came up with a staged-diffuser expansion chamber. This one has the first part of its diffuser diverging at 7-degrees, and a shorter second part at 12-degrees, with the parts being proportioned 70/30 for length. The baffle cone remained the same, converging at 16-degrees. And, because the staged diffuser is a bit shorter than one having a constant 8-degree angle, I was able to lengthen the lead-in pipe to 13.0-inches.

Of course, I was prepared to accept a slight drop in peak power to gain in terms of power spread; I wasn't prepared for what actually happened. For the first test with this staged-diffuser chamber, we changed back to the stock cylinder head, and checked to see how far below the previous 18.52 bhp we had dropped. What happened was that we found a slight gain in peak power, to 18.75 bhp—still at 6500 rpm—in addition to a considerable improvement in broad-range power. Switching to the Webco head pushed the entire power curve upward, with the maximum being raised to 19.97 bhp, and useful power stretched from 3500 rpm all

(Continued on page 115)



not by a long shot it isn't !!

There's certainly nothing top secret about the classified pages of Cycle Magazine. They're wide open to the searching eyes of every buyer who's in the market for the product or service that he knows can be found in Cycle's Classified Advertising pages.

The 350,000 monthly buyers of Cycle are your guarantee of knowing that your ad is being read by people who are constantly looking for and buying motorcycle products. It is these people to whom you MUST direct YOUR advertising as do the many key advertisers appearing in this issue and in each issue throughout the year.

No doubt about it—there's a vast market of buyers searching the classified advertising pages of Cycle and it's important that your ad be exposed to this prime buying audience. Prove to yourself that the leading motorcycle magazine **MUST ALSO** be the leader in sales responses to the many classified ads presently enhancing its pages—it makes a great deal of sense—give it a try.

See classified section for rate information or write to
HAL CYMES, Classified Advertising Mgr.
ZIFF-DAVIS PUBLISHING COMPANY
 One Park Avenue, New York, N. Y. 10016

Planning to move?

Let us know **6 to 8 weeks in advance** so that you won't miss a single issue of **CYCLE**.

Attach old label where indicated and print new address in space provided. Also include your mailing label whenever you write concerning your subscription. It helps us serve you promptly.

Write to: P.O. Box 1092, Flushing, N.Y. 11352, giving the following information.

Change address only.

Extend subscription. Enter new subscription.

(1) 3 years \$15 (2) 2 years \$11 (3) 1 year \$6

Payment enclosed (1 extra issue per yr. as a BONUS). Bill me later.

AFFIX LABEL
 If you have no label handy, print OLD address here.
 name _____ please print
 address _____
 city _____ state _____ zip-code 0326
 name _____ please print
 address _____
 city _____ state _____ zip-code _____

Add'l postage: \$1 per year outside U.S., its poss. & Can.

CHAMBERS *Continued from page 57*

the way right up to 7500 rpm.

Having found an expansion chamber that appeared to be the answer to a tuner's prayers, I then decided to do some experimentation with lead-in and outlet pipe diameters. I could have saved myself the trouble in both instances. Within the lengths dictated by installation space and the chamber-proper's size, the rather arbitrarily chosen lead-in diameter of 1 7/8-inches proved to be exactly what the Yamaha engine liked. I tried reducing the lead-in pipe to 1 3/4-inches in diameter, and increasing it to 2-inches, and both of these changes gave a distinct drop in power over the entire operating range. The 1 3/4-inch pipe was closer to being right, but only close. If you cannot find 1 7/8-inch tubing, in suitable bends, in your area, and want to build one of these chambers for your own Yamaha, then by all means use 1 3/4-inch tubing rather than 2-inch. Still you must remember that 1 7/8-inches is the right diameter. I'll add here that I find this sensitivity to diameter on the part of the Yamaha DT-1 engine quite remarkable; it is something that will bear closer investigation in the future. I have in mind a series of tests to determine the relationship between lead-in pipe diameter and length (they are, I am convinced, interrelated) but that will have to wait until other, more pressing matters are handled.

Constructing an expansion chamber with a clamp to permit quick changes in outlet pipes was next on the schedule, and the tests with same went very quickly and conclusively. My formula predicted that the correct outlet pipe diameter would be between .58 and .62 lead-in diameters, and that proved to be the case. Multiplying the lead-in pipe's 1.77-inch inside diameter by the above factors gave an outlet diameter of between 1.025 and 1.098 inches. Tubing with 1 1/8-inch O.D. and a wall-thickness of .049-inch has an inside diameter of 1.027-inches, which falls within the prescribed range, so that's what was used. The next-larger standard tubing size, 1 1/4-inch, with an inside diameter of 1.152, was too large in theory—and proved to be so in practice. I should mention here that the popular notion about being able to get better low-end performance from an expansion chamber by substituting an oversize outlet pipe is entirely wrong. The right diameter is *right*, period. Anything larger simply depresses power output through the entire engine speed range.

Smaller outlet pipes were also tried, with the result predicted in my previous article on expansion chamber design: reducing the outlet to .902-inch, only an eighth below the correct size, produced a small drop in power—but a very large increase in engine temperature. This effect is something to keep in mind when you're experimenting with expansion chambers, for there is a very thin line between maximum power and a melted piston.

Find out why. Send for illustrated KONI brochure, cut-away drawing & free decal kit. Send 25¢ to cover postage/handling.

Bikoni Limited.
150 Green St., Hackensack, N.J. 07601
 C/5/72

Name _____
 Address _____
 City _____ State _____ Zip _____
 Make _____ Model _____ Year _____

That's the way it is.

The precise control of a motorcycle at speed on the highway as well as the world's racing circuits dictates the choice of KONI adjustable shock absorbers.

KONI makes it big!

Wins 1971 World Grand Prix, Can-Am Series, SCCA Formula 5000 Series and Trans-Am 2.5 Series



Ivon Duhamel, Canadian Champion, raced KONI equipment. Kawasaki Co. wins 1971 Trans-Am 2.5 Series.

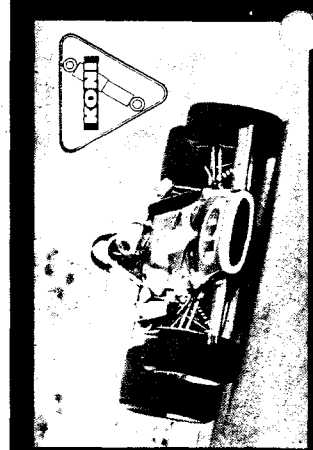

David Hobbs in McLaren won 1971 "Continental" Series. 1969-1970 Series also won by KONI.

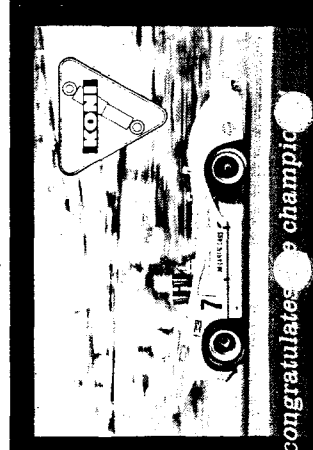

Peter Rayson won 1971 Can-Am. Denis Hume won 1970 Series in KONI equipped McLaren.

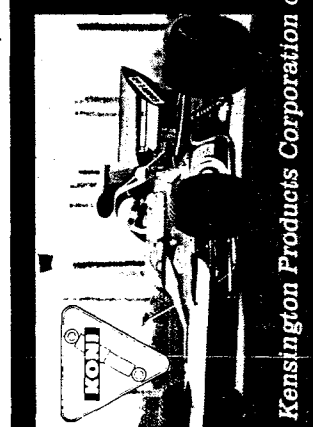

Jackie Stewart in Tyrrell Ford won 1971 World GP. In 1970 he won the KONI adjustable shock absorber.

Kensington Products Corporation congratulates the champion

HELMETS

Confederate
Maple Leaf
Fleur-De-Lis
Stars & Stripes

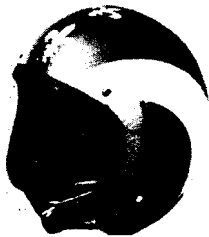

Meets all
U.S. standard
safety
regulations

List ~~\$29.95~~
\$17.95

\$1.35 postage

SNAP-ON BUBBLE SHIELD



In Clear, Amber,
Smoke or Blue

\$.35 postage

\$ 3.95

CHAIN-A-PART

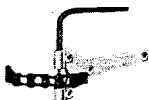

MODEL A-3540
For Mini-bikes
(Stamped steel
handle) \$3.25



MODEL C-3540
For #35 & #40 roller chains. \$5.25

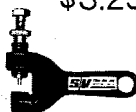

MODEL A-4050
For #40 & #50
roller chains \$7.25



MODEL B-3540
For #35 & #40
roller chains. \$7.25

\$.75 postage

CYCLE COVERS

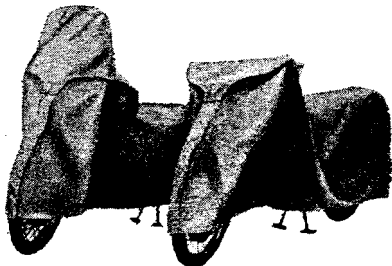

- Cycles up to 200 cc. \$4.50
- Cycles over 200 cc. \$4.50

\$1.00 postage

D.K. SPEED PRODUCTS
P.O. BOX 3956
CHARLOTTE, N.C. 28203
CIRCLE NO. 45 ON READER SERVICE PAGE

116

Having constructed a chamber with a clamp-mounting for its outlet pipe, we were able to conduct a proper test of my theory that an expansion chamber's outlet pipe should be located well forward of its conventional position. A few years ago, I tried a set of chambers on a roadracing Bridgestone with outlet pipes moved forward, inside the baffle cones. The thought was to place the forward end of the outlet pipe ahead of the baffle, and thus deny the sonic wave an easy escape out the back of the baffle cone—which should provide a stronger reflection and (hopefully) in the end boost power output. Lacking a dynamometer, I was not able to determine if there was, in fact, any increase in power attributable to this change. I did, however, note that there was very much less noise with the "inside stingers" and while this meant little at the time (who wants a muffled roadracing motorcycle?) the effect has since become rather important.

Anyway, I now had the means for testing the theory and that's what we did—taking power readings with the outlet pipe extending out the back of the chamber, shoved all the way forward, and at points between. And there was indeed a slight increase in power to be had with the outlet pipe in full-forward position. A very, very slight increase, and most of that at lower revs. You'd have to say that there was no worthwhile improvement over the conventional outlet pipe location in terms of power—but the change does drop sound pressure from about 115 dB(A) to 100 dB(A), without any other form of muffling, and that alone is sufficient reason for relocating the outlet. Just don't go for any half-measures in this regard: we found, in moving the outlet pipe back and forth, that unless the forward end of the pipe is either moved up ahead of the baffle cone, it should be left back at its tip. Power drops quite markedly as the outlet pipe is pushed up into the baffle cone, reaches a minimum at about the halfway point, and then slowly rises to regain maximum value as the pipe's forward end is finally brought ahead of the baffle.

A final note on expansion chambers: in this kind of work, the dynamometer is a kind of time machine. You can compress a year of cutting, welding and field-testing into a week, with a dynamometer. My first expansion chamber for the DT-1 was, as previously noted, a horsepower winner—better in this regard than any of the others, including the Yamaha chambers—but I don't like to think how long it would have taken to arrive at a design for the second, far-better chamber, without a dynamometer to tell me where I was and where I had to go. I like that dynamometer so much, I don't even mind that it proved me wrong about there being a lot of power to be had in simply relocating an outlet pipe.

With all the dithering around amidst a pile of expansion chambers concluded, we moved on to an experiment with porting, port timing, and carburetion. This phase

LOWEST PRICES ON CYCLE TROPHIES
 NOW
 LOWEST PRICES
 '71 CATALOG
 NEW SUPER BONUS
 DISCOUNT PLAN
PJY WHOLESALE
FACTORY-DIRECT
FREE, FAST
DELIVERY
 Send for your FREE
 CATALOG
OVER
300 TROPHIES TO
CHOOSE FROM
 Eddie Retchins
TROPHY WORLD, INC.
 A Subsidiary of TROPHY ENTERPRISES INC.
 Dept. FC
 6400 N.W. 77th COURT
 MIAMI, FLORIDA 33166

Exclusively specializing in
HONDA Parts!
 & accessories for all makes & models
1-DAY MAIL ORDER SERVICE ANY-
WHERE — AIRMAIL IF REQUESTED
 Send year, model, engine & frame
 no. with all orders. Write for free
 list of all Honda Repair Manuals
 and Parts Catalogs.
THRIFTY LAD HONDA, Dept. B
 2411 Lincoln Bl., Santa Monica,
 Calif. 90405, (213) 392-3066

nuts and bolts don't loosen anymore!

Loctite offers a range of products to keep parts together . . . everything from weld strength to thread lockers you can remove with a wrench (LOCK N' SEAL-2114). Ask your local speed shop, cycle shop, hardware store, or auto parts jobber. Send stamped, self-addressed envelope, request full color Loctite guide #472

LOCTITE® better ways to
keep parts together
 LOCTITE CORPORATION NEWINGTON, CONN. 06111

MOTORCYCLE INSURANCE

Insure with the Largest
Oldest and most Reliable
 All forms of insurance for Motorcycle
 and Scooter Owners, and Riders At Low
 Rates.

- Bodily Injury and Property
Damage Liability
- Fire, Theft & Collision

Write for applications and information on our budget premium plan. No obligation. Immediate coverage on acceptable applicants. Local adjusters handle your losses. All ages accepted except those under the age of 16 in Colorado and Minnesota, and under 21 in Washington, D.C. (No insurance written for residents of Delaware Maryland, Massachusetts, New Hampshire, New York, Nevada, North Carolina, South Carolina or Virginia.)

MOTORCYCLE UNDERWRITERS
 39 So. La Salle St. Suite 1116-B
 Chicago, Illinois 60603

CYCLE

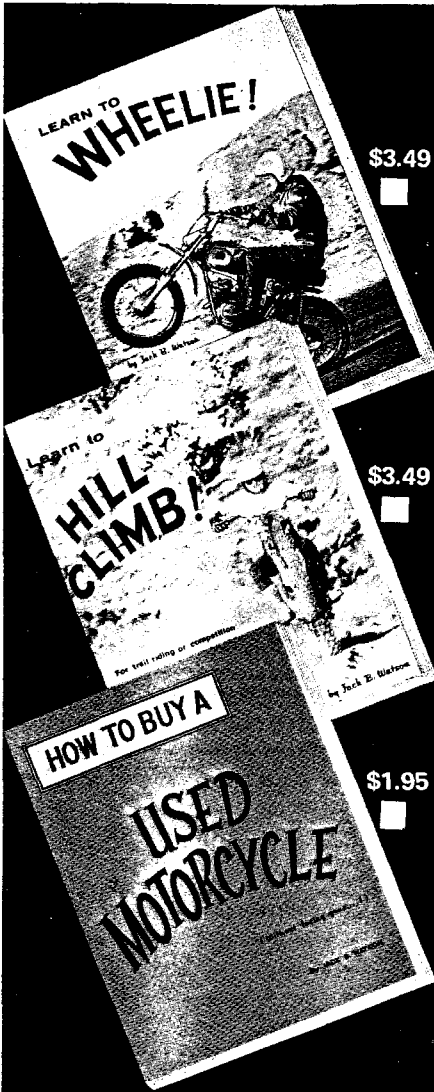

\$3.49

\$3.49

\$1.95

ALL 3 BOOKS ONLY ■ \$7.50

LEARN TO WHEELIE

You can do 300 foot breathtaking wheelies on any bike from 50 cc to 500 cc. It's all in the technique not engine power. Forty action packed illustrated pages lead you step by step through the learning process.

LEARN TO HILL CLIMB

What to do when the front end comes up. How to use body english. How to ride down steep hills. How to turn around half way up. Learn the best riding stance and much much more.

HOW TO BUY A USED MOTORCYCLE

Don't be gyped! Learn to spot a lemon. Find out about false dealer guarantees. Every book includes a complete wholesale and retail blue book price list.

Check the boxes next to the books you want and send cash, check or money order to POWER RIDER CO., Dept. 350, Box 158, Saugus, Calif. 91350.



California residents must enclose an additional 5% sales tax. Allow 4 weeks normal delivery or enclose 50¢ extra each book for rush 1st class mail. Guaranteed Satisfaction or your money back.

NAME _____

ADDRESS _____

CITY _____ STATE _____ ZIP _____

was begun with a lot of hours spent scuffing around inside the Yamaha cylinder's ports with a high-speed grinder. No attempt was made to alter the port's shapes, as we felt that Yamaha knew more about that than any of us, but we did smooth all the surfaces (removing casting flaws, etc.). The only modification of any consequence was in the exhaust port's width. Past experience (our own, and that of others) has shown that the safe limit for exhaust port width is 62-percent of bore diameter. The stock port was 1.57-inches in width; we marked off a new window shape in machinist's blue, and widened the port to 1.71-inches. Our intention was to retain the same exhaust timing, with the port opening 94-degrees after top center, but the port roof got raised slightly in the clean-up process and the very generous chamfer we ground around the exhaust port, to make life easier for the piston rings, effectively raised the port a bit more. In the end, we found that we had gained 4-degrees, with the exhaust opening an even 90-degrees after top center.

We also gained some horsepower. There was a very slight loss in low-end power, and a gain of about half-a-horse at the 6500 rpm power peak, but at 7000 rpm the porting job was worth *three horsepower*. That gain is, we think, almost entirely due to the added exhaust port width.

The next step was to try altering the intake timing, which gives a total of 160-degrees of port-open duration in the stock DT-1E. The logical thing was to try Yamaha's MX intake timing, which is what we did. You can get this timing by using an MX piston, which has a rear skirt .160-inch shorter than the stock piston—or you can shorten the stock piston's skirt by the required amount. In either case (and we tried both) maximum output rises by about 1 3/4-bhp, and the improvement is above one horsepower all the way from 6000 rpm to the 7500 rpm redline. There is a slight loss in power below 4500 rpm, but we consider that loss to be acceptable in light of the gains at high engine speeds. Oddly enough, there was neither gain nor loss to be found by running with one or two rings. We tried the MX piston, and the shortened stock piston with one and two rings, and simply could not detect any difference. Undoubtedly there would be a difference at higher revs, but there certainly was none below 7500 rpm.

For our last magical trick, we unbolted the DT-1E's stock 26mm carburetor, and substituted a 30mm MX carburetor—which we were just certain was going to give us a big surge in power, if only at maximum revs. What we got was a big surprise: there was slightly more power at 6000 rpm, and a marked loss at all other speeds. And no matter how we fiddled the jetting, the loss was still there. In reviewing all the pertinent data, it does seem most likely that the 30mm carburetor would work as we expected if the intake port was reshaped to match the one in the MX cyl-

Motorcycle Accessories

The new 1972 Webco catalog is the most comprehensive in the motorcycle accessories industry. 100 pages, fully illustrated, featuring the most wanted equipment and high performance components. Includes the complete line of high quality Webco products for motorcycle enthusiasts.

WEBCO
MOTORCYCLE ACCESSORIES



Price \$1.00... includes Webco racing flag decal.

WEBCO INC.

P.O. BOX 429 ■ VENICE, CALIFORNIA 90291

TOURING EUROPE

Write for FREE Brochure on our Purchase Scheme

Harvey Owen

THE B.S.A./TRIUMPH CENTER

Dept 12, 181 Walworth Road, LONDON, S.E.17. ENGLAND
01-703 0282

BARGAIN HUNTERS

DISCOUNT GOODIES

Tanks, Forks Tubes, Bars, Mufflers, Sissy Bars, etc., CHEAP!
FREE CATALOG

TOMBSTONE CYCLE

820 Kildonan Drive, Winnipeg 15, Manitoba, Canada

Locks helmets to cycles—SAFELY

\$3.95

Post paid
Garvon-Lok

Strong, chrome-plated lock ends helmet theft. Clamps to handlebars of all popular cycles except Harley "74" and "Sportster." Installs in minutes with tamper-proof screws. Mail check or money order to:

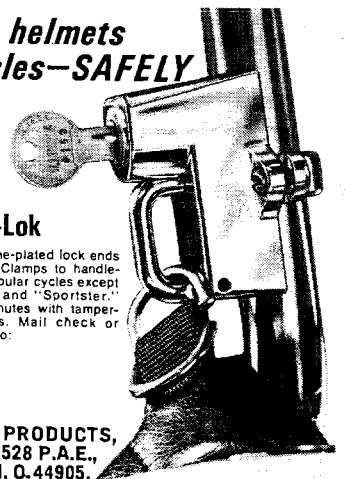

GARVON PRODUCTS,
Dept. A, 1528 P.A.E.,
Mansfield, O. 44905.

Send me _____ Garvon Locks at \$3.95 Each
Enclosed is payment of \$ _____

NAME _____

ADDRESS _____

CITY _____

STATE _____ ZIP _____

TURN IT ON!



Whatever you ride . . . wherever you ride . . . D-A Speed-Sport Motor Oil belongs! D-A, the oil specialist, blends Speed-Sport to protect performance engines under the toughest competition. That means *your* engine will have maximum protection under *all* conditions. D-A Speed-Sport Motor Oil . . . available from selected dealers . . . everywhere.



RACING DIVISION
D-A LUBRICANT COMPANY, INC.

1331 West 29th Street • Indianapolis, Indiana 46208
CIRCLE NO. 47 ON READER SERVICE PAGE

inder—which entails raising the top of the port by 6-millimeters, or .236-inch. Of course, doing that will require that you use either the MX piston, or remove the second ring from the stock piston, as the ends of the second ring will otherwise pop out into the port and snag—with highly unfortunate consequences. We cannot advise you on the overall effect of enlarging the intake port, because we didn't try it. The result should be an improvement in top-end power—but then that's what we expected with bolting on the 30mm carburetor, and we were wrong about that.

With all these experiments out of the way, we returned the DT-1 to stock specification, with the standard cylinder, head and pipe, and made another power run. The results were almost precisely the same as when we made our first check, which assured us that nothing had changed during the course of this project. And then we put together a combination of the modifications we had found to be really worthwhile: my expansion chamber, the ported cylinder, a shortened piston and the Webco cylinder head.

How did this combination work? It worked to the tune of 22.9 bhp, at 6500 rpm. That's an increase of 44.5-percent, obtained without exceeding the manufacturer's redline for this engine, and in fact, by raising the true horsepower peaking speed only 500 rpm. Moreover, there is more power with the modified engine over the entire useable power range. The difference is not just so many dynamometer numbers, either. We carted the DT-1 off to the desert for a real-life tryout, and the way it goes—compared to the stocker—is nothing short of astonishing.

You can discover all this yourself, for a very small investment in money and with a reasonable expenditure in time. We have provided all the expansion chamber dimensions, and those for porting the cylinder. You can get a Webco head from Webco, or any dealer who handles their products, and they are going to manufacture the expansion chambers for those who don't want to make them from scratch.

You won't have to spend any money for extra carburetor jets or racing spark plugs. We used the NGK B9ES plug throughout our tests (brief experiments with colder plugs indicated that they had advantages with the stock cylinder head, but were unnecessary with the Webco head) and the stock #160 mainjet gave us the best horsepower—as did the stock ignition timing. Make no changes in those areas, unless you are anticipating some very hard running in warm weather, in which case a switch to an NGK B10 plug (or its equivalent) may be indicated. The only other change we could recommend, in conjunction with the general modifications, would be to enlarge the DT-1's aircleaner. We discovered that with the fully-modified engine, the stock aircleaner element is restricting air flow enough to drop the power output down by about .25-bhp.



Whether you're a beginner or an expert, dirt riding is where it's at! So "think dirt", and think how much more fun having the right equipment can make.

The new Diamond Catalog offers the latest in quality accessories and high performance components for the off-road rider. You'll also appreciate our prompt service.

free Order your Catalog for just \$1.00 and we'll send you a colorful "think dirt!" bumper sticker free...but act now, this offer is limited.

DIAMOND MANUFACTURING, Dept. CY

735 E. 12th Street, Los Angeles, Calif. 90021

\$1.00 ENCLOSED Send me the new Diamond Catalog plus my free "think dirt!" bumper sticker.

Name _____

Address _____

City _____

State _____ Zip _____

PAYMENT MUST BE ENCLOSED WITH ORDER

SAVE!

BUY FACTORY-DIRECT....
from world's leading manufacturer

- Assembled—ready to present
- Wholesale low, low prices
- Artistic color combinations
- Rush "PDQ" service
- Distinctive designs
- Satisfaction guaranteed

Write for free catalog
Trophyland USA Inc.
DEPT. C, 798 W. 83 ST. P.O. BOX 4606, HIALEAH, FLA. 33014

kosman specialties

MANUFACTURERS OF:

ALLOY RACING WHEELS
QUICK CHANGE SPROCKETS
DISC BRAKES
OIL TANKS
OIL FILTERS

DISTRIBUTORS OF:

TITAN HY-VO PRIMARY DRIVES
REDLINE RACING FRAMES
ROUTT BIG BORE CYLINDERS
ARD MAGNETOS

SEND \$1.00 FOR CATALOG

KOSMAN M-C SPECIALTIES
340 FELL STREET
SAN FRANCISCO, CA. 94102

EVEN BETTER THAN IT LOOKS.

Way out there, miles and miles from anywhere, your motor singing in your ears, you really find out what touring is all about. It's just you and your machine, each counting on the other.

That's when you learn to appreciate your Bates Fairing. The way it protects you from rocks and other hazards, the way it cuts through the wind. You're free and comfortable...able to stay in the saddle for hours and still arrive refreshed.

Your Bates Fairing is also beautiful. The Fiberglass is laid-up by hand, carefully reinforced at stress points for just the right combination of strength and flexibility. Colors are hermetically sealed in with a high-gloss surface finish.

The Plexiglas shield is a full 3/16" thick... tinted if you like. The headlight ring and front strip hiding the shield mount bolts are triple-chrome plated. And Bates Fairings are custom designed and fitted to each cycle—not a "universal catch-all." Mounting them is a job you can do alone, using simple hand tools.

Cycle Mechanics said in a recent road test, "The styling is excellent. The sweeping curves and flawless finish complement the appearance of the bike... The Bates Fairing is a good dollar value and, in our opinion, it has more tasteful style." We couldn't say it better or agree more.

Find out for yourself by ordering your Bates Fairing now — they're available for most street and touring machines.

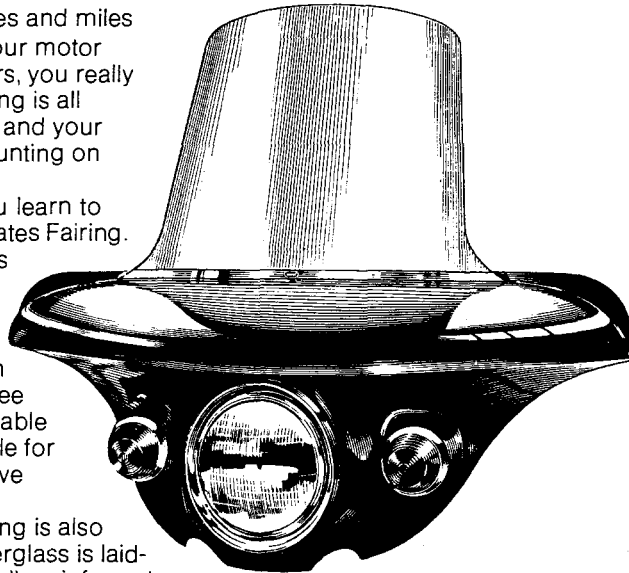

We had intended to try a batch of add-on mufflers, and test them for effectiveness both in terms of power reduction/gain and noise reduction. All were, as it happens, very far from being effective enough to bring the exhaust noise from a conventional expansion chamber down to meet the AMA's 92 dB(A) limit. A couple of them were close, when used in conjunction with the inside outlet pipe, but we elected not to proceed with a series of sound-level tests simply because they would have been meaningless. Why? Because all of these silencers used fiberglass packings as a sound attenuator, and experience has demonstrated to everyone's satisfaction that fiberglass is either shredded by vibration and blown out on the ground—or becomes loaded with carbon and oil. In either case, the fiberglass muffler quickly loses its effectiveness. We see no point in spending a lot of hours testing devices that must inevitably have a very short useful life.

One thing we can tell you is that a silencer of adequate size has no effect on power output worth mentioning. Some of the silencers we tried on the dynamometer would trim a very small amount of power from the high speed range and add it on down low; others had the opposite effect. In no case was there an important difference—with the possible exception of the Hooker expansion chamber, which did show a very slight overall gain when a straight tube was substituted for its fiberglass-surrounded muffler sleeve. This, we think, indicates that the Hooker chamber could use a smaller muffler sleeve to provide a bit more pressure-bleed resistance.

The entire question of muffling motorcycle engines clearly deserves a lot more investigation, and we are now moving in that direction. Next year, the limit for off road vehicles in California will be 88 dB(A). We're going to work on the problem in hope that it's not already too late; we seem to be the only ones who are taking the matter seriously at the moment. If all goes well, we'll have some numbers for you in the near future. ©

Bates Fairings

Give make, model and year of cycle _____

Fairing Primer-\$64.50 Black-\$69.50 White-\$69.50 Metal Flake-\$79.50 \$ _____

If Metal Flake, specify color: Red Blue Silver Gold Green Purple

Striping-Specify color or colors _____ \$5.00 extra \$ _____

Specify Shield Color: Clear Solar Green Light Blue

Height of rider, when standing _____

Send 50% deposit with order to: _____ Total _____ \$ _____

ACCESSORY HOUSE BOX 1770, LONG BEACH, CALIFORNIA 90801

Name _____

Street _____

City _____ State _____ Zip _____

Complete Bates Catalog available for \$1.00. Enclosed free with order.

G

