



BRIDGESTONE MOTORCYCLES

# TUNING UP FOR COMPETITION



QUALITY MACHINE FROM JAPAN

# BRIDGESTONE MOTORCYCLES TUNING UP FOR COMPETITION

## CONTENTS

Introduction.....	4
Tuning up 350 GTR for Road Racing.....	7
Tuning up 350 GTR for Scrambling .....	10
Tuning up 175 Dual Twin/Hurricane Scrambler for Road Racing.....	13
Tuning up 175 Dual Twin/Hurricane Scrambler for Scrambling.....	16
Tuning up 100 Sport for Road Racing/Scrambling .....	21
Special Attention in Tuning Up.....	25



All Japan Grand Prix 1967  
Fuji Speedway  
No. 3 Bridgestone winner



3  
Cross-country race in England

## INTRODUCTION

How to boost the performance of a standard Bridgestone motorcycle engine for racing and competition.

The increasing use of motorcycles has created more than ever many forms of competition, such as speed racing, scrambling, cross-country racing, drag racing, hill climbing and trials. This booklet has been specially compiled for the Bridgestone motorcyclist who wishes to participate in such events, to guide him in tuning up his machine so that he may "hot up" the machine himself.

Do it yourself and have fun. Suggest you have the parts made locally.

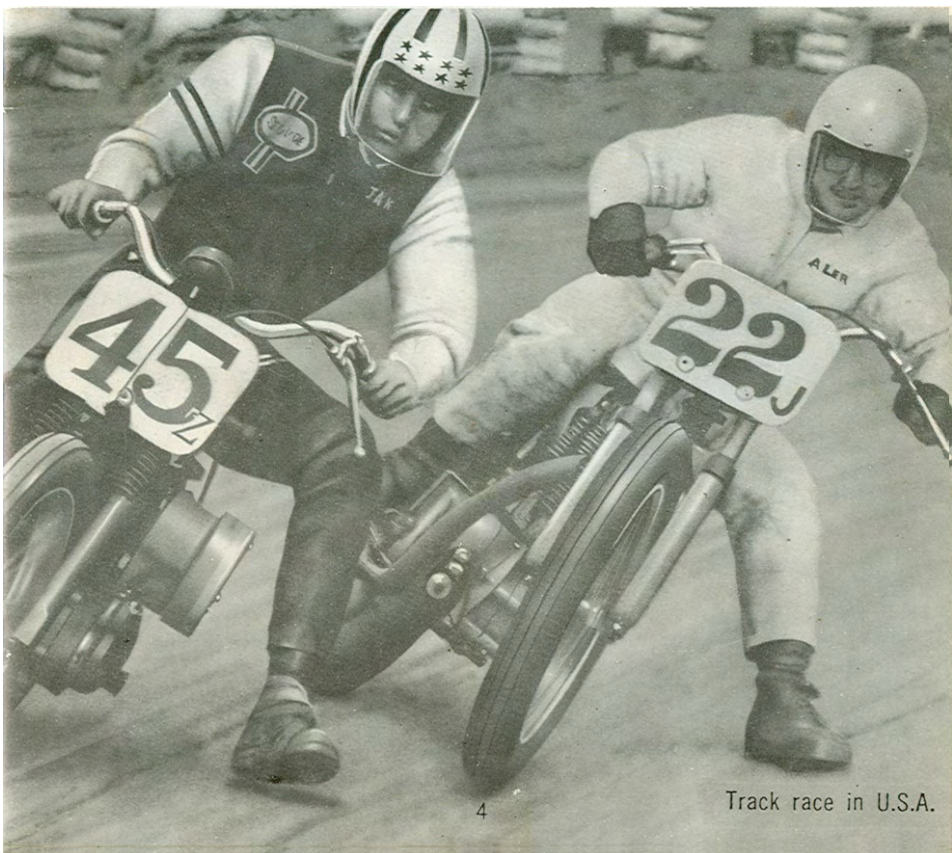

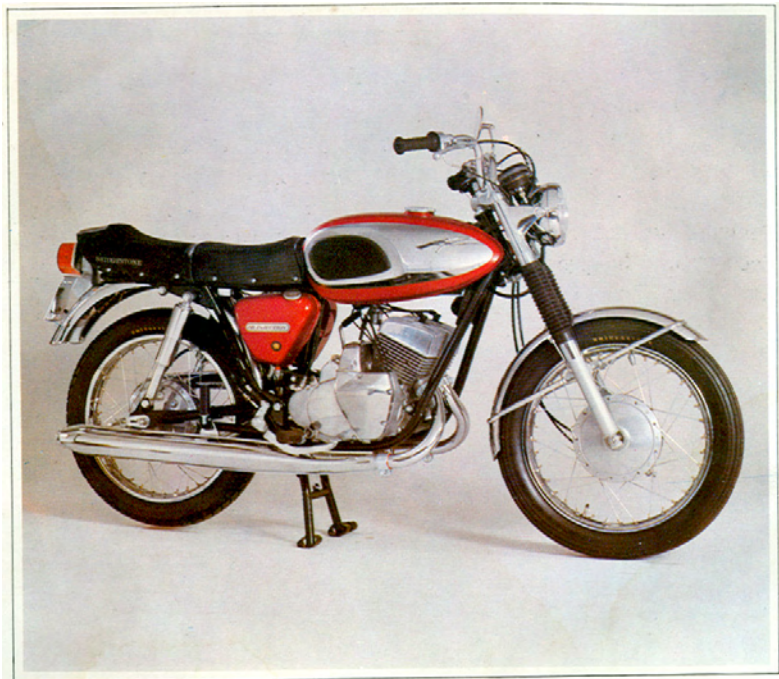

# **BRIDGESTONE 350** *GTR*

---

**IS AN IDEAL MACHINE FOR RACING**

Aluminum alloy cylinders, rotary disc valves, primary kick starter which enables starting in any gear, 6-speed transmission, dry type racing clutch, independent speedometer and tachometer, powerful brakes and totally enclosed carburetors for protection against water and dirt.

\* Maximum speed 100-110 mph

\* Acceleration from standing start to 60 miles an hour in 5.2 seconds, and 1/4 mile in 13.7 seconds.

TUNING-UP  
**350** *GTR*  
FOR  
**ROAD  
RACING**

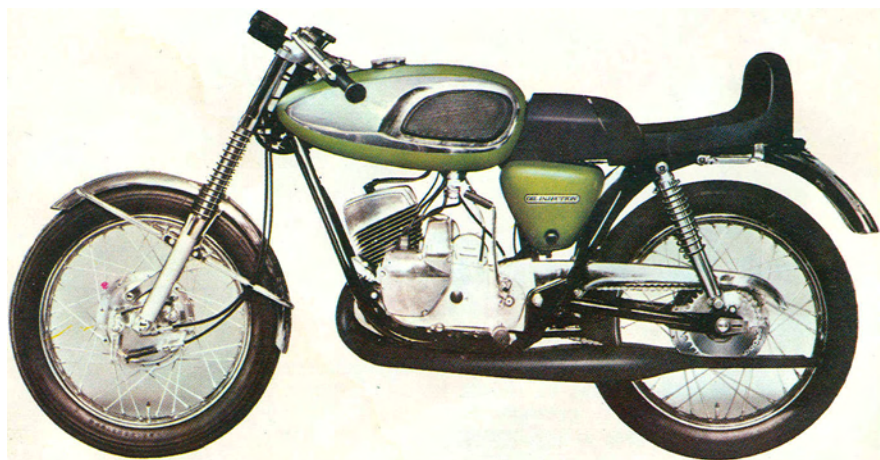

**BRIDGESTONE**

**350 GTR**

**For ROAD RACING**

**3. DESIGN OF MUFFLER**

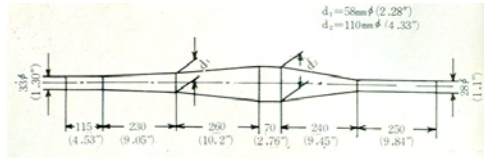

**4. ENLARGE TWO TRANSFER PORTS**

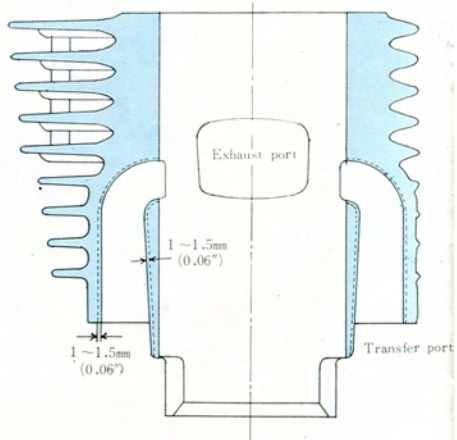

Enlarge both transfer ports with a fine electric grinder as shown, to eliminate flow friction of gas.

**1. MODIFICATION OF ROTARY DISC VALVES**

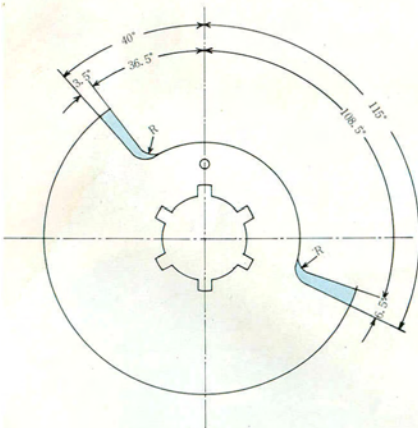

Enlarge valve gap at the disc as shown. Finish the cut corners (R) carefully to prevent cracking of the disc at high speed.

**2. CARBURETOR SETTING**

Standard size carburetor will be effective for races, except main jet size from No. 90 (original size) to No. 100.

**5. CYLINDER PORT TIMING**

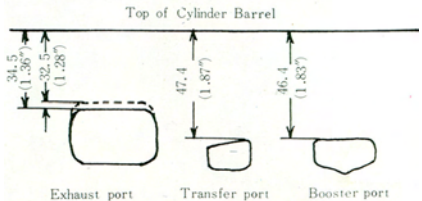

Raise exhaust port 2 mm (0.079 inches) with an electric grinder as shown. Transfer port & Booster port are not required to be changed.

## 6. INCREASE COMBUSTION CHAMBER PRESSURE

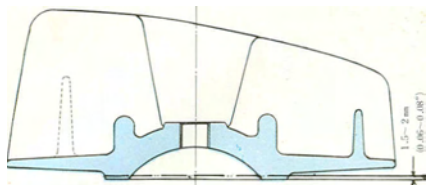

Raise combustion chamber compression by shaving down the cylinder head base as shown.

## 7. MODIFICATION OF ROTARY DISG VALVE GOVER

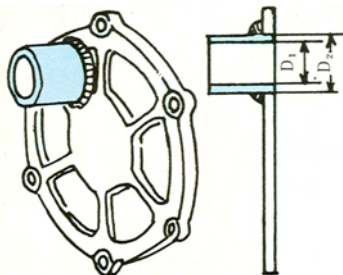

$D_1 = 30\text{mm Dia.}$   
(1.2")

$D_2 = 34\text{mm Dia.}$   
(1.34")

$D_2 = D_1 + 4\text{ mm (0.16")}$

To suit the 30 mm bore carburetor, make and weld a larger tube, as shown.

## 8. IGNITION TIMING

8-1. Ignition Timing:  $25^\circ$  Before Top Dead Center same as standard timing.

8-2. Piston Displacement Before Top Dead Center: 3.6 mm (0.142 inches) same as standard displacement.

8-3. Point Gap of Contact Breaker: 0.25-0.3 mm (0.01-0.012 inches) instead of 0.3-0.4 mm (0.012-0.016 inches) of original gap

8-4. Spark Plug: NGK B-8HN-IOHN

## Performance of Standard Engine

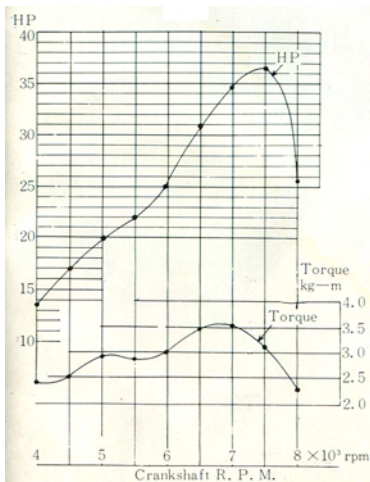

## Performance after Tune-up

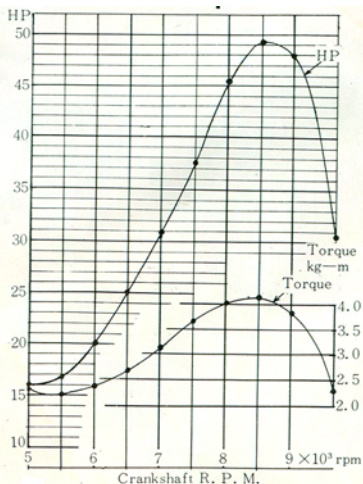

TUNING-UP  
**350***GTR*  
FOR  
**SCRAMBLING**

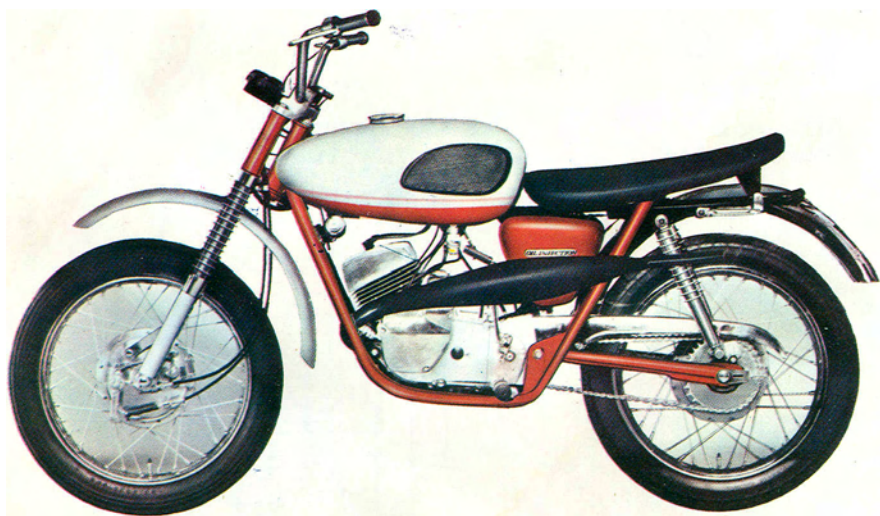

# BRIDGESTONE 350 GTR

## For SCRAMBLING

For tuning, it is only necessary to make the following modifications:

### 1. DESIGN OF MUFFLER



### 2. INCREASE COMBUSTION CHAMBER COMPRESSION

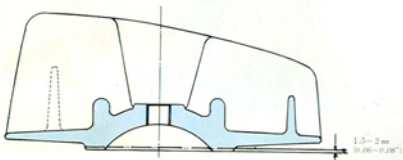

Raise combustion chamber compression by shaving down the cylinder head base as shown.

### 3. CARBURETOR SETTING

To obtain higher power output at high speed, the AMAL racing type carburetor 26mm main bore and with a separate float chamber is preferable to VM 26 mm bore originally equipped.

### 4. REMARKS

The following items do not require any modification except the point gap of contact breaker and spark plug.

4-1. Point Gap of Contact Breaker:

0.25-0.3 mm (0.010-0.012 inches) instead of 0.3-0.4 mm (0.012-0.016 inches) of original gap.

4-2. Spark Plug: NGK B-8HN~B-9HN

## Performance of Standard Engine

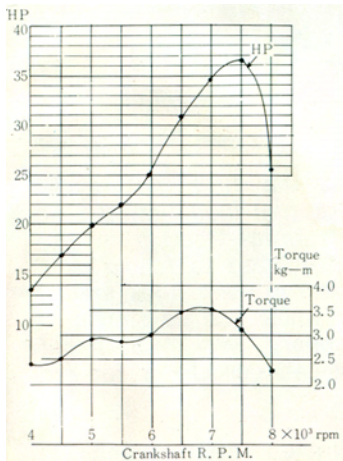

## Performance after Tune-up

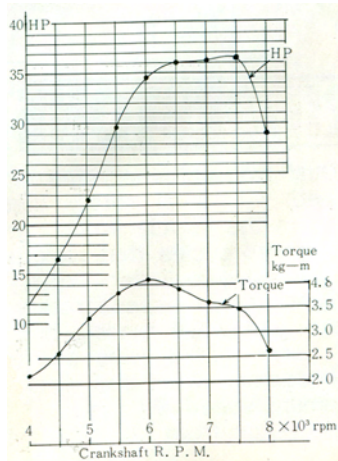



## **BRIDGESTONE175 *Dual Twin Hurricane Scrambler***

175 Dual Twin and Hurricane Scrambler are the first motorcycles equipped with dual rotary disc valves for fuel induction and acclaimed in the "Cycle World" as "a design break-through in production motorcycles that all others will be obliged to follow".

Aluminum alloy cylinders, rotary disc valves, primary kick starter; dual transmission 4-speed rotary shift gear which can be shifted to 5-speed gear while running or when stationary with "sport shift lever", large brake hubs and totally enclosed carburetor for protection against water and dirt.

\* Maximum speed 80 mph

\* Acceleration from standing start to 1/4 miles in 18 seconds.

**TUNING-UP**  
**175** DUAL TWIN  
HURRICANE SCRAMBLER  
**FOR**  
**ROAD**  
**RACING**

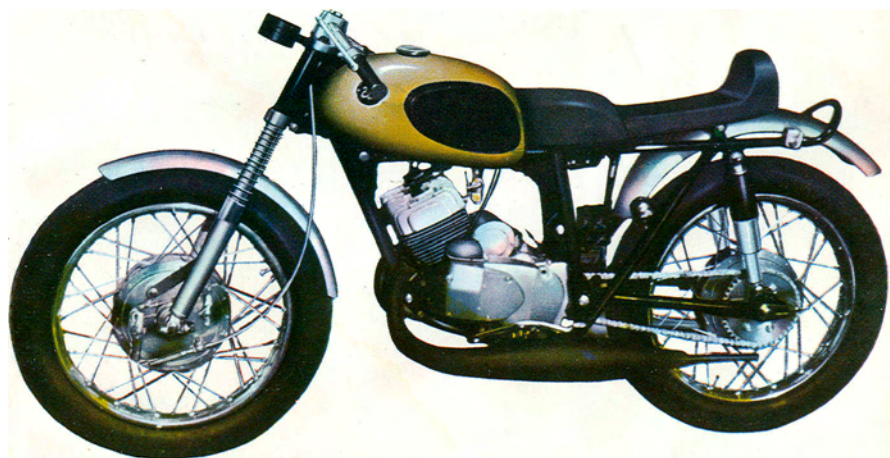



## Performance of Standard Engine

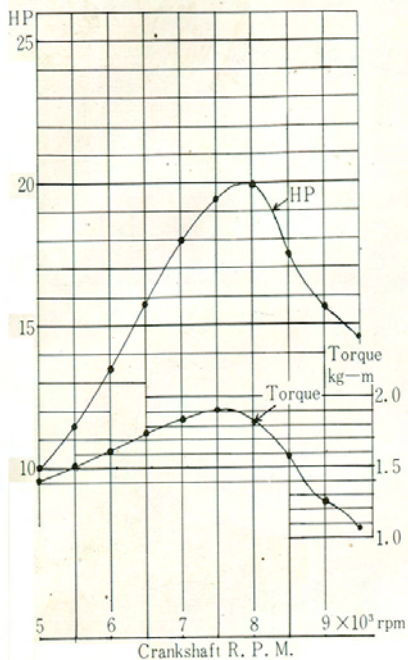

## Performance after Tune-up

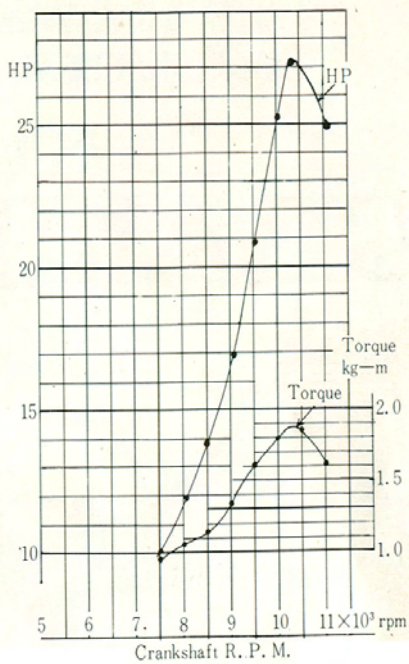

**TUNING-UP**  
**175** DUAL TWIN  
HURRICANE SCRAMBLER  
**FOR**  
**SCRAMBLING**

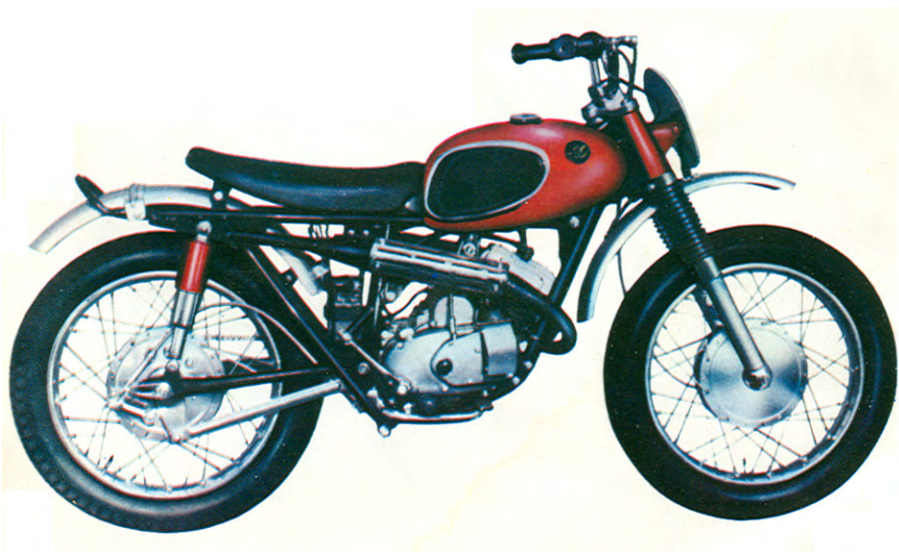



## Performance of Standard Engine

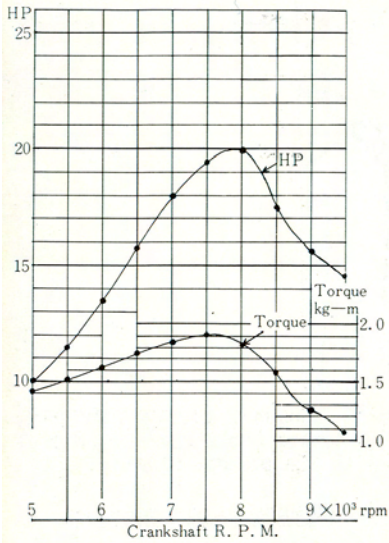

## Performance after Tune-up

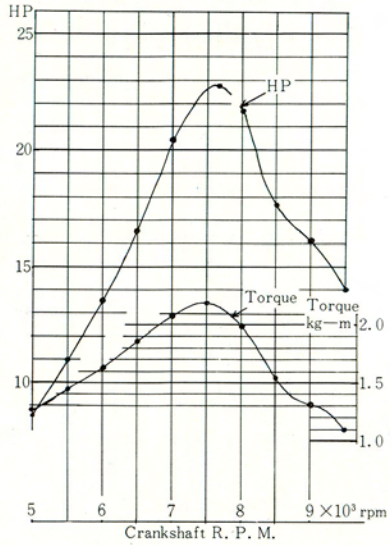

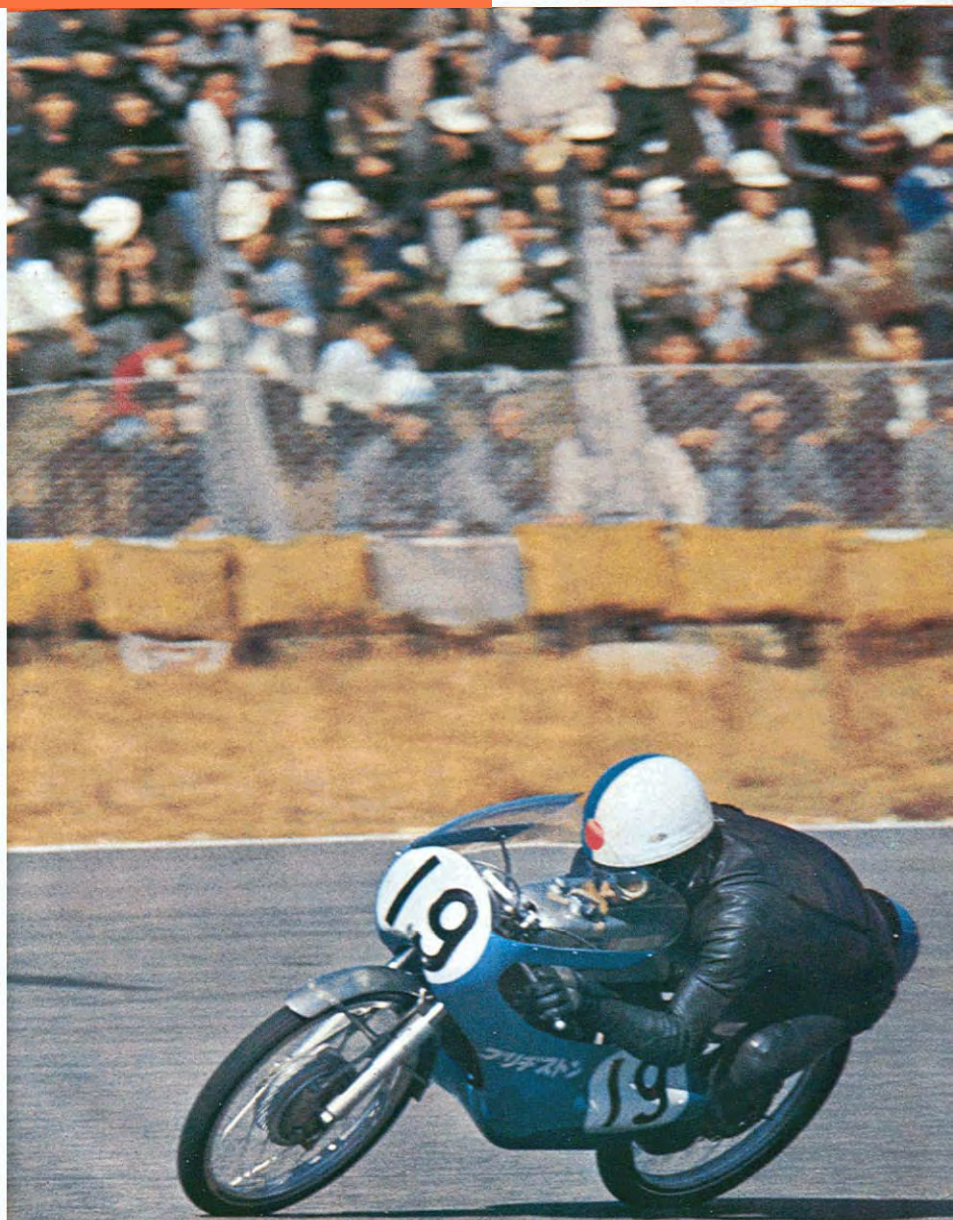

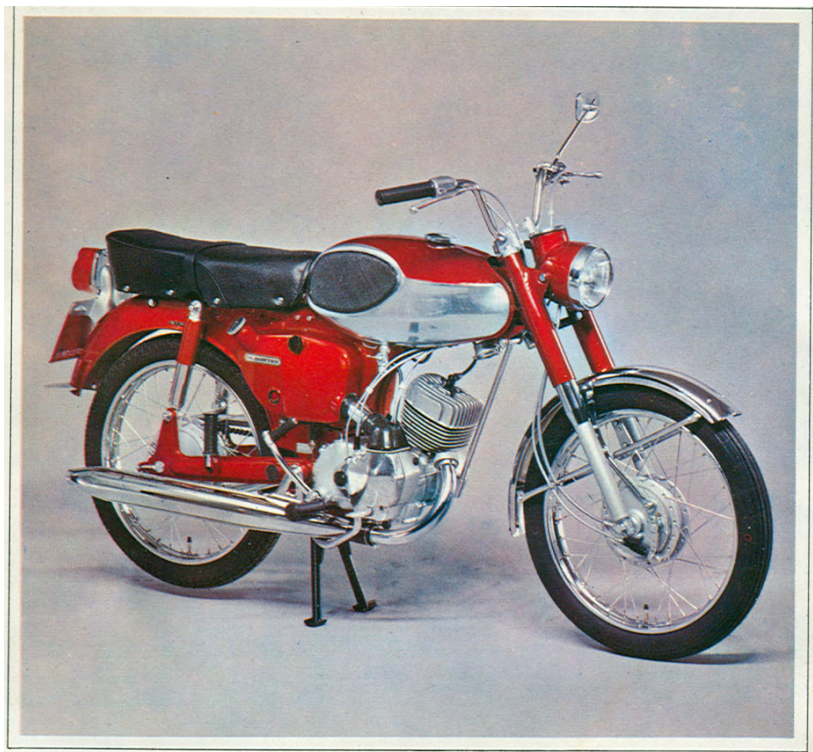

## **BRIDGESTONE 100 Sport**

100 Sport is the most exciting motorcycle in its class and is loved by every racing enthusiast as a winning machine.

Aluminum alloy cylinder, rotary disc valve, primary kick starter, 4 speed transmission, large brake hubs and totally enclosed carburetor protection against water and dirt.

\* Maximum speed 72 mph

\* Acceleration from standing start to 1/8 miles in 12 seconds.

TUNING-UP  
**100** *Sport*  
FOR  
**ROAD RACING**  
and  
**SCRAMBLING**

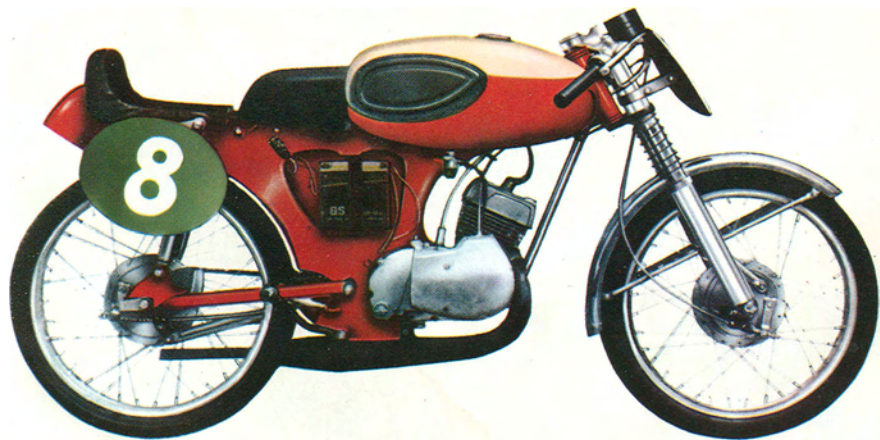

BRIDGESTONE

100 Sport

For ROAD RACING  
and SCRAMBLING

### 1. MODIFICATION OF ROTARY DISC VALVE

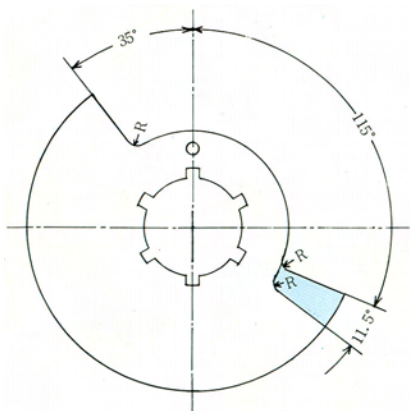

Enlarge valve gap of the disc as shown. Finish the cut corners (R) carefully to prevent cracking of the disc at high speed.

### 2. CARBURETOR SETTING

To obtain higher power output at high speed, VM22 mm bore carburetor is recommended instead of 17mm bore originally fitted. Main jet size: around No. 330.

### 3. DESIGN OF MUFFLER

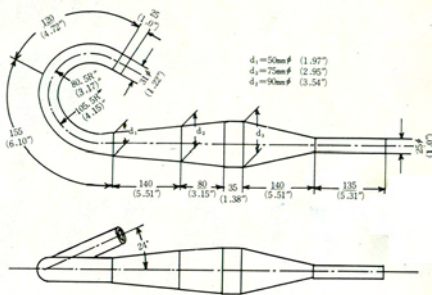

### 4. ENLARGE EXHAUST PORT

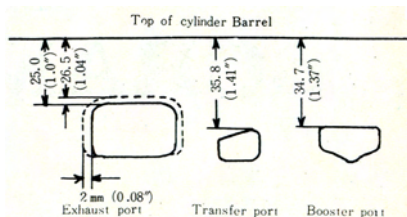

Raise the exhaust port with a fine electric grinder as shown to eliminate flow friction. The position of transfer ports and 3rd transfer port (booster port) need not be changed.

### 5. FINISH OF CYLINDER

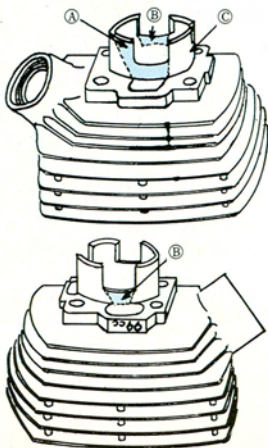

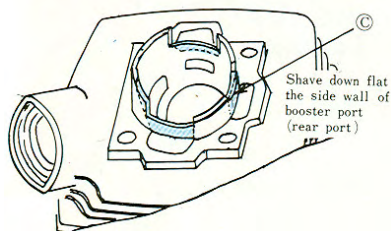

Cut out the shaded part of cylinder shown for quick passage of gas. Note that the transfer port should be diagonally cut out to meet the shape of the inlet port opening at the right side (Rotary disk valve side) only. Shave down flat the circular side wall of the booster port C, as shown.

#### 6. MODIFICATION OF PISTON

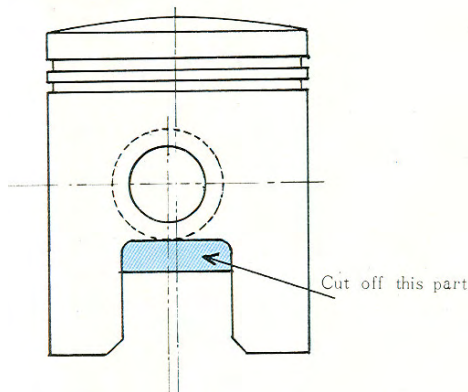

Cut out the side wall of the piston as far as the outside diameter of the piston boss as shown.

#### 7. INCREASE COMBUSTION CHAMBER

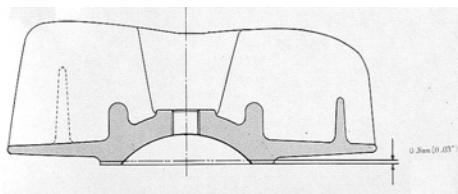

Raise combustion chamber compression by shaving down the cylinder head base as shown.

#### 8. MODIFICATION OF RIGHT CRANKCASE

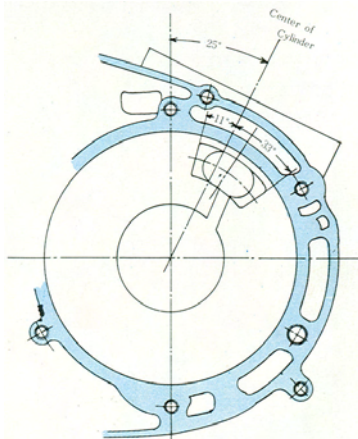

Enlarge the air intake port of the right crankcase to correspond with the new rotary valve timing.

#### 9. IGNITION TIMING

- 9-1. Ignition Timing:  $23^{\circ}$ - $24^{\circ}$  Before Top Dead Center instead of  $19^{\circ}$  of original timing.
- 9-2. Piston Displacement Before Top Dead Center: 2.30 mm (0.090 inches) instead of 1.59 mm (0.063 inches) of original displacement.
- 9-3. Point Gap of Contact Breaker: 0.25-0.30 mm (0.01-0.012 inches) instead of 0.3-0.4 mm (0.012-0.016 inches) of original gap.
- 9-4. Spark Plug: NGK B-9HN-B-10HN

## Performance of Standard Engine

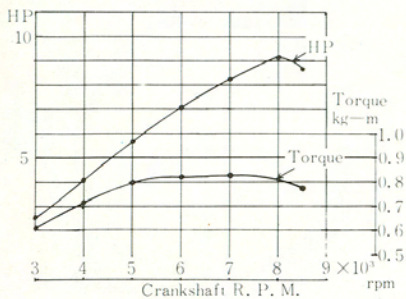

## Performance after Tune-up

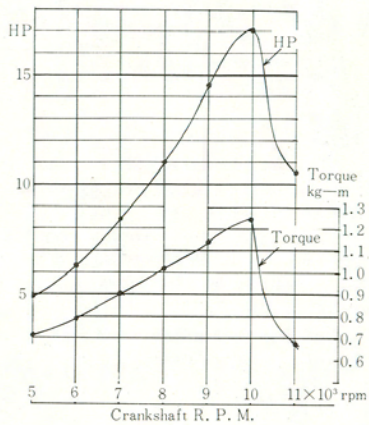



# SPECIAL ATTENTION IN TUNING-UP

Tuning up requires great care in carrying out the following modifications.

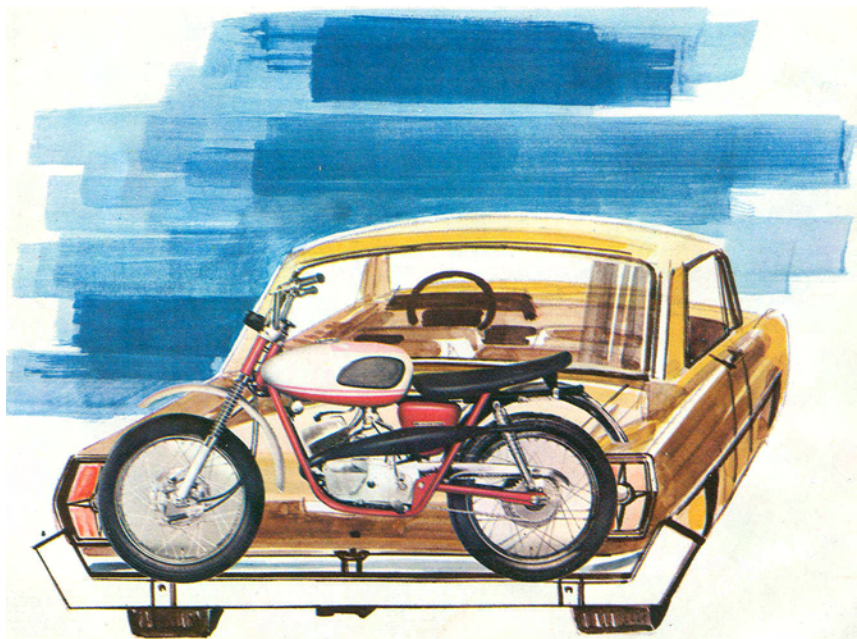

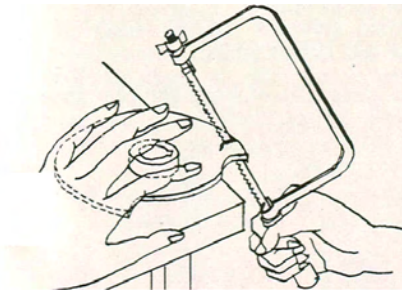
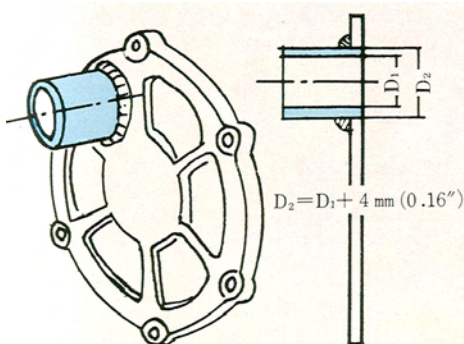
**1. ENLARGE ROTARY DISC VALVE****2. MODIFICATION OF ROTARY DISC VALVE COVER**

To weld the replace tube at the disc valve cover, cut off the original tube and weld the larger tube, as shown.

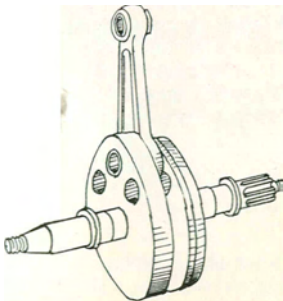
**3. MODIFICATION OF CRANKSHAFT**

To raise crankcase compression in the case of 100 Sport, plug the con rod pin hole and the two balancing holes with ALUMINUM PUTTY. "DEVCON-F" is recommended.

**4. HOW TO SHAVE DOWN THE CYLINDER HEAD BASE**

Shave down the head base with turning lathe and then lay it on a surface plate or plate glass and rub the cylinder carefully and smoothly over emery paper.

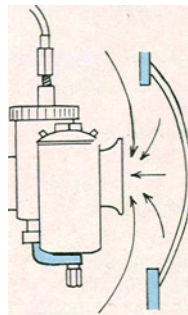
**5. GAP BETWEEN THE REPLACE CARBURETOR AND CARBURETOR COVER**

Check the gap between carburetor cover and carburetor, to allow free flow of air into carburetor as shown. When a little more gap is necessary, fit tin plate to the cover.

**6. CHECK THE PISTON SURFACE**

Check the piston surface after breaking in the machine, and if any scratches on the surface are noticed, lap the spots with fine emery paper.

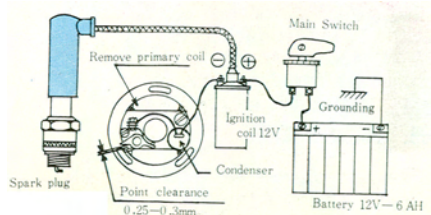
**7. MODIFICATION OF IGNITION SYSTEM**

To raise the engine speed quickly and reduce the inertia mass of revolving parts, battery ignition is generally preferable to the flywheel magneto. (The ignition of 100 Sport is by flywheel magneto and 175 Dual Twin/Hurricane Scrambler, 350 GTR are of battery ignition.)

It is to be noted that substitution of battery ignition depends on the nature of the competition because for long endurance trials, there is a possibility of the battery discharging.

If it is desired to modify the ignition system of 100 Sport from flywheel magneto to battery, refer to the following instructions:

A battery of 12V-6AH should be used instead of the standard 6V -3AH fitted to the machine.

In this case, remove flywheel magneto and primary ignition coil.

The lighting coil also should be removed from the magneto frame.

Remarks: When battery is fully charged, its life will be 7 hours continuous running at high speed, but it must be remembered that sparking will become weaker after 3-4 hours. It is, therefore, recommended that a spare battery be kept in reserve for actual racing.

#### 8. FUEL MIXTURE RATIO

8-1. When the standard oil injection system is used for racing, the following mixed fuel ratio is recommended. High octane gasoline and oil (25 to 1) in the fuel tank, and 2 cycle engine oil (Castrol racing oil) in the oil tank.

8-2. When oil injection system is removed to reduce friction loss of oil pump mechanism and weight of oil tank, use mixed gasoline and oil (Castrol racing oil) of 15-20 to 1 ratio.

#### 9. CARBURETOR SETTING

The size of, main jet should be selected according to the race course, climate etc.

Therefore, the final choice is left to your own judgement.

#### 10. GEAR RATIO OF SPROCKETS

The gear ratio of front and rear sprockets should be decided finally by practicing on the race course with sprockets of different ratios.

Generally, the ratio which gives the maximum speed on the course is adopted.

#### 11. HINTS FOR ENGINE STARTING

In the case of push-starting at flagging, keep in mind the following procedure to start engine quickly, and without fall.

##### 11-1. Engine Warming Up

Warm-up the engine, with the spark plug of a lower grade heat range than the racing plug recommended. But do not fail to replace the plug with the actual plug before starting.

11.2. To stop the engine after warming up, ready for starting, the following procedure is necessary while running, to restart quickly.

A. Close the fuel cock before switching off.

B. Open and close the throttle grip five or six times to bring the level of fuel down to half of the carburetor chamber.

C. Engage the first gear by closing the throttle grip, and stop engine by applying brakes.

D. Then only, switch off the engine, otherwise the spark plug will become wet with the fuel sucked in before the crankshaft stops revolving, making immediate restart difficult.

11-3. Switch on the engine 10 seconds before starting, open the fuel cock 5-7 seconds before flagging.

## 12. MODIFICATION OF FRAME

A. Generally, the following parts are dismantled according to the Racing Regulations of different countries, to reduce weight.

- Head light assembly
- Tail light assembly
- Rear view mirror
- Main stand & side stand
- Number plate bracket
- Steering lock comp.
- Horn assembly

B. Other modifications of frame

The following modifications may be advisable for long endurance trials, especially in rocky regions.

### 12.1. STRENGTHEN FOOTREST BAR

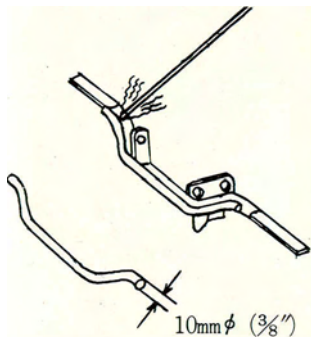

The footrest bar should be strengthened by welding a steel bar as shown, to prevent bending or breaking through continuous and severe strain in racing.

### 12.2. STRENGTHEN BRAKE PEDAL STOPPER

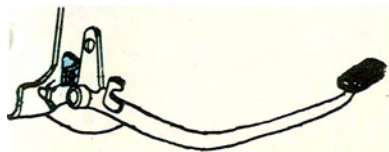

To strengthen brake pedal stopper, attach a reinforcing plate as shown.

### 12-3. MODIFICATION OF GEAR CHANGE PEDAL

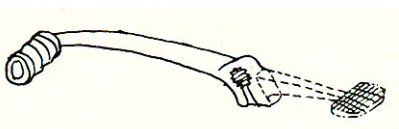

To change the pedal tread action, cut the rear tread bar as shown.

### 12-4. MODIFICATION OF FRONT SUSPENSION

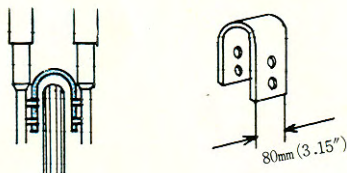

Install the U type steel plate to reinforce the front fork.

### 12-5. MODIFICATION OF REAR FRAME

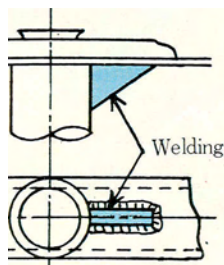

To reinforce rear frame, weld triangular plates on the cross member of the frame as shown.

**12-6. REINFORCEMENT OF CHAIN ADJUSTER BRACKETS**

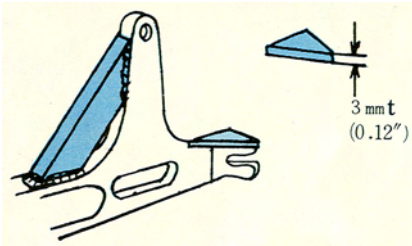

To reinforce brackets of chain adjuster, weld triangular plates as shown.

**12-7. MODIFICATION OF MUDGUARD**

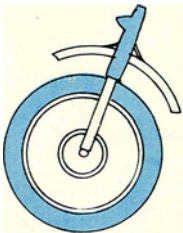

a. Raise front mudguard as shown, to prevent clogging with mud.

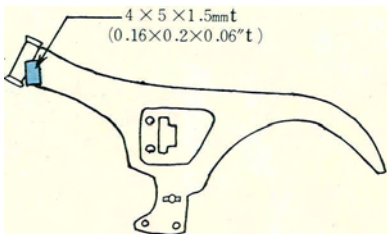

b. It will be also advisable to cut off a part of rear mudguard as shown, to prevent accumulation of mud, if the racing regulations permit.

**12-8. OTHERS**

a. Air Hole of Fuel Tank Cap

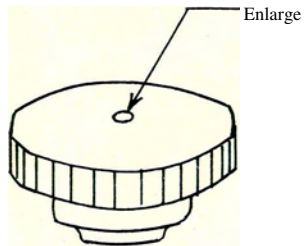

It may be well to enlarge the hole on fuel tank cap as shown, to prevent possibility of stoppage of flow of fuel due to clogged hole.

b. Wire Chain Connector-Clip

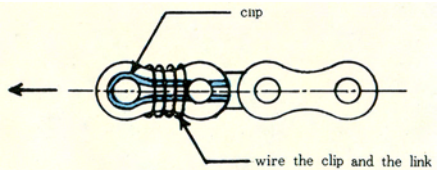

Wire the chain connector-clip as shown, to fix it securely to the connector.

c. Checking of Tire Balance

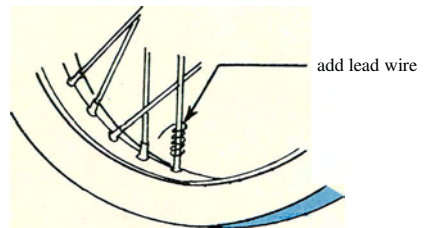

Clamp the balancing weight to the spokes as shown, if needed.

Remarks: To check the wheel balance, spin the wheel several times: a balanced wheel will stop in any position. If the wheel regularly stops, in the same position, clamp a balancing weight to the spoke opposite to the lowest spoke.





NOTES



BRIDGESTONE TIRE CO., LTD.

Printed in Japan  
L&TUP